

Lesson 1: What Lies Behind “Same Shape”?

Classwork

Exploratory Challenge

Two geometric figures are said to be similar if they have the same shape but not necessarily the same size. Using that informal definition, are the following pairs of figures similar to one another? Explain.

Pair A:

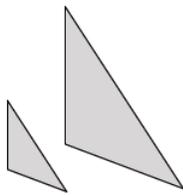

Pair B:

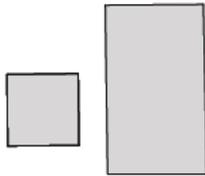

Pair C:

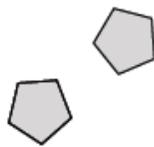

Pair D:

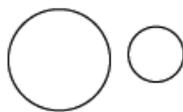

Pair E:

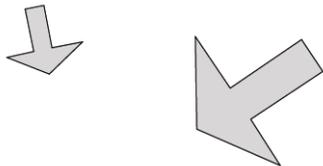

Pair F:

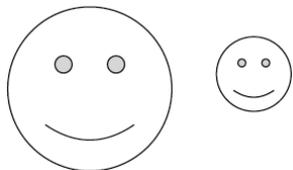

Pair G:

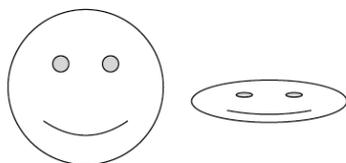

Pair H:

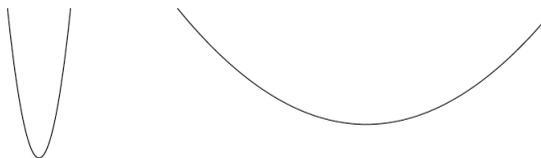
**Exercises 1–6**1. Given $|OP| = 5$ in.a. If segment OP is dilated by a scale factor $r = 4$, what is the length of segment OP' ?b. If segment OP is dilated by a scale factor $= \frac{1}{2}$, what is the length of segment OP' ?

Use the diagram below to answer Exercises 2–6. Let there be a dilation from center O . Then $Dilation(P) = P'$ and $Dilation(Q) = Q'$. In the diagram below, $|OP| = 3$ cm and $|OQ| = 4$ cm, as shown.

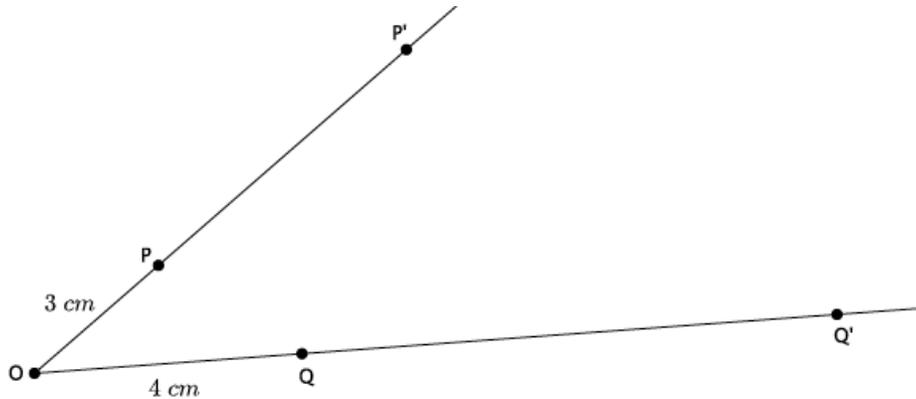

- If the scale factor is $r = 3$, what is the length of segment OP' ?
- Use the definition of dilation to show that your answer to Exercise 2 is correct.
- If the scale factor is $r = 3$, what is the length of segment OQ' ?
- Use the definition of dilation to show that your answer to Exercise 4 is correct.
- If you know that $|OP| = 3$, $|OP'| = 9$, how could you use that information to determine the scale factor?

Lesson Summary

Definition: A dilation, a transformation of the plane with center O , with scale factor r ($r > 0$) is a rule that assigns to each point P of the plane a point $Dilation(P)$ so that

1. $Dilation(O) = O$, (i.e., a dilation does not move the center of dilation.)

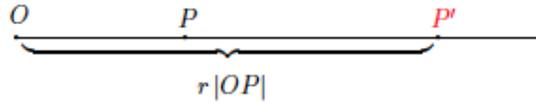

2. If $P \neq O$, then the point $Dilation(P)$, (to be denoted more simply by P') is the point on the ray \overrightarrow{OP} so that $|OP'| = r|OP|$.

In other words, a dilation is a rule that moves points in the plane a specific distance, determined by the scale factor r , from a center O . When the scale factor $r > 1$, the dilation magnifies a figure. When the scale factor $0 < r < 1$, the dilation shrinks a figure. When the scale factor $r = 1$, there is no change in the size of the figure; that is, the figure and its image are congruent.

Problem Set

1. Let there be a dilation from center O . Then $Dilation(P) = P'$ and $Dilation(Q) = Q'$. Examine the drawing below. What can you determine about the scale factor of the dilation?

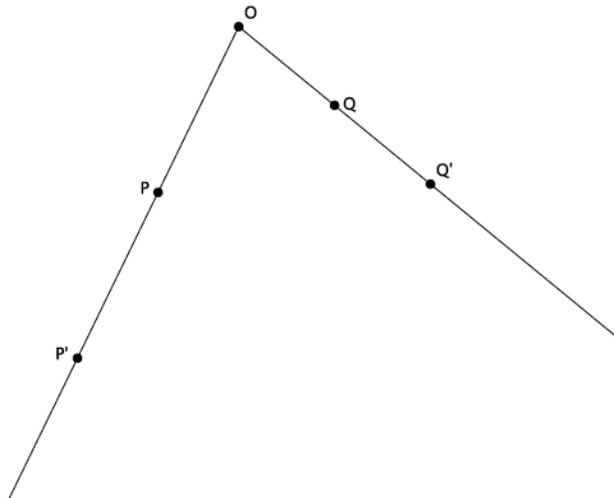

2. Let there be a dilation from center O . Then $Dilation(P) = P'$, and $Dilation(Q) = Q'$. Examine the drawing below. What can you determine about the scale factor of the dilation?

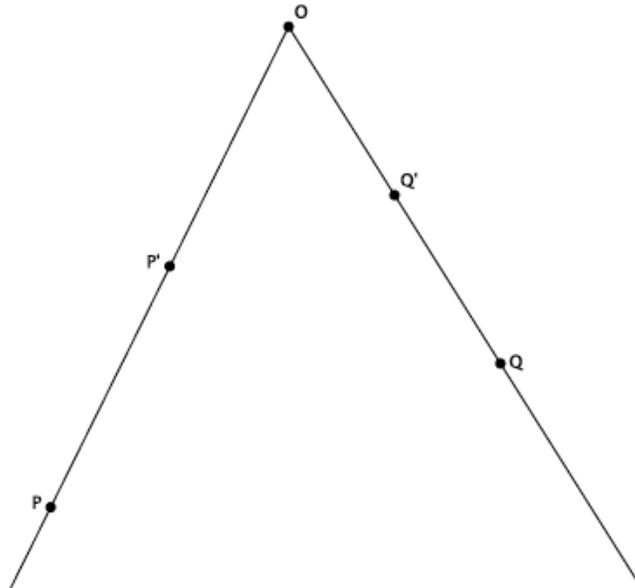

3. Let there be a dilation from center O with a scale factor $r = 4$. Then $Dilation(P) = P'$ and $Dilation(Q) = Q'$. $|OP| = 3.2$ cm, and $|OQ| = 2.7$ cm, as shown. Use the drawing below to answer parts (a) and (b). Drawing not to scale.

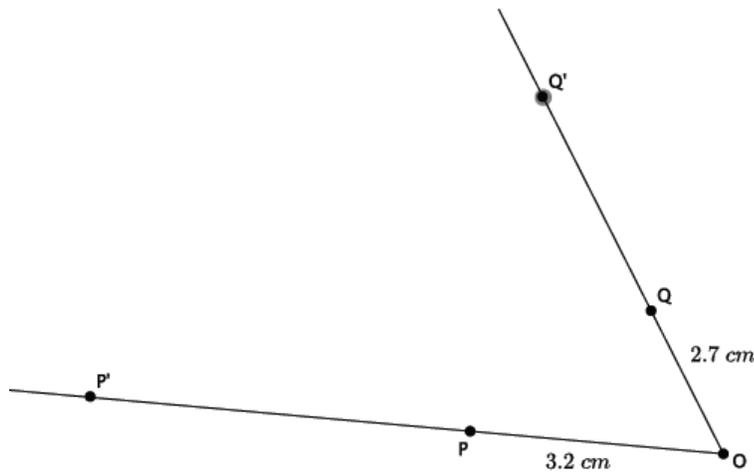

- Use the definition of dilation to determine the length of OP' .
- Use the definition of dilation to determine the length of OQ' .

4. Let there be a dilation from center O with a scale factor r . Then $Dilation(A) = A'$, $Dilation(B) = B'$, and $Dilation(C) = C'$. $|OA| = 3$, $|OB| = 15$, $|OC| = 6$, and $|OB'| = 5$, as shown. Use the drawing below to answer parts (a)–(c).

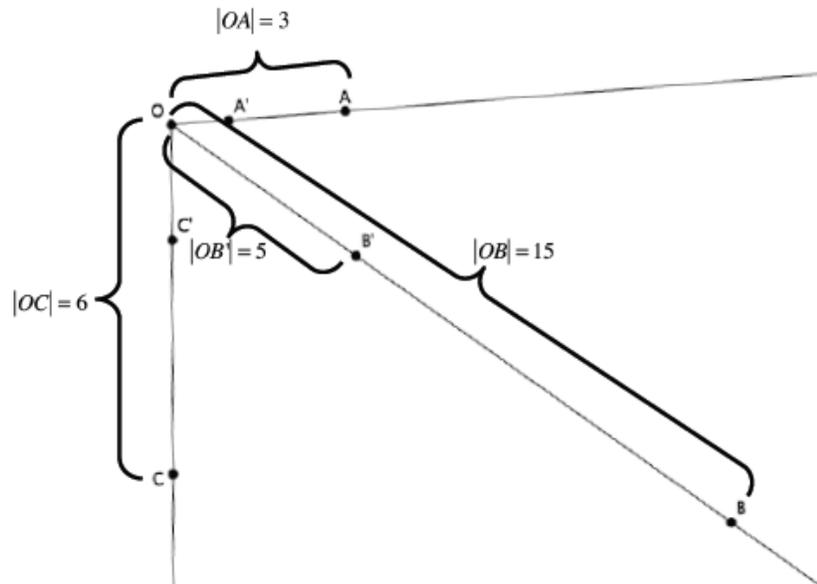

- Using the definition of dilation with lengths OB and OB' , determine the scale factor of the dilation.
- Use the definition of dilation to determine the length of OA' .
- Use the definition of dilation to determine the length of OC' .

Lesson 2: Properties of Dilations

Classwork

Examples 1–2: Dilations Map Lines to Lines

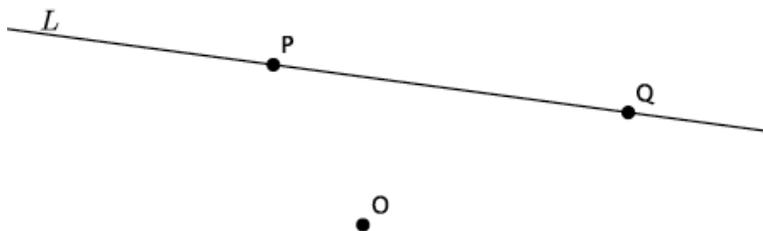

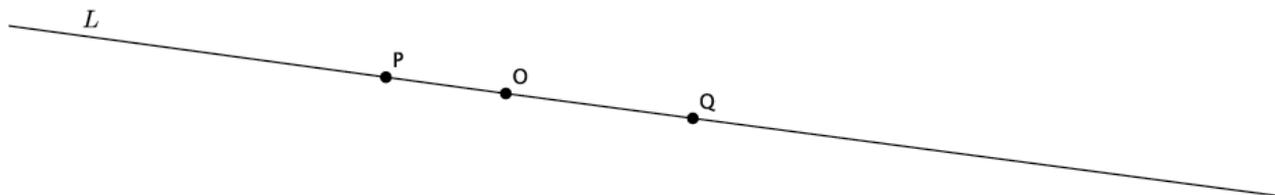
Example 3: Dilations Map Lines to Lines**Exercise**

Given center O and triangle ABC , dilate the triangle from center O with a scale factor $r = 3$.

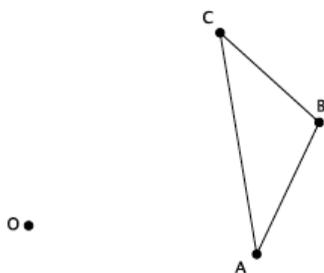

- a. Note that the triangle ABC is made up of segments AB , BC , and CA . Were the dilated images of these segments still segments?

- b. Measure the length of the segments AB and $A'B'$. What do you notice? (Think about the definition of dilation.)
- c. Verify the claim you made in part (b) by measuring and comparing the lengths of segments BC and $B'C'$ and segments CA and $C'A'$. What does this mean in terms of the segments formed between dilated points?
- d. Measure $\angle ABC$ and $\angle A'B'C'$. What do you notice?
- e. Verify the claim you made in part (d) by measuring and comparing $\angle BCA$ and $\angle B'C'A'$ and $\angle CAB$ and $\angle C'A'B'$. What does that mean in terms of dilations with respect to angles and their degrees?

Lesson Summary

Dilations map lines to lines, rays to rays, and segments to segments. Dilations map angles to angles of the same degree.

Problem Set

1. Use a ruler to dilate the following figure from center O , with scale factor $r = \frac{1}{2}$.

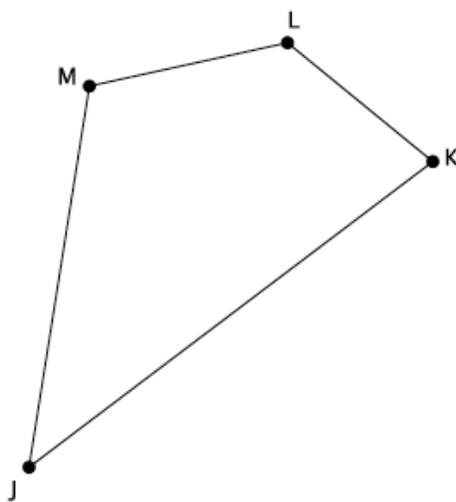

O

2. Use a compass to dilate the figure $ABCDE$ from center O , with scale factor $r = 2$.

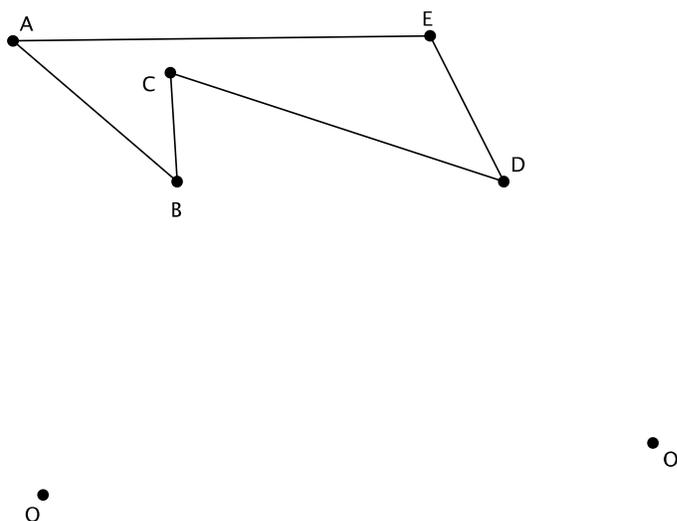

- a. Dilate the same figure, $ABCDE$, from a new center, O' , with scale factor $r = 2$. Use double primes ($A''B''C''D''E''$) to distinguish this image from the original.
- b. What rigid motion, or sequence of rigid motions, would map $A''B''C''D''E''$ to $A'B'C'D'E'$?

3. Given center O and triangle ABC , dilate the figure from center O by a scale factor of $r = \frac{1}{4}$. Label the dilated triangle $A'B'C'$.

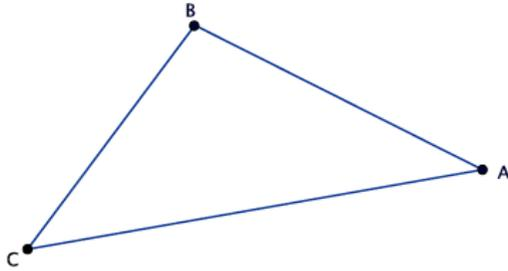

•
o

4. A line segment AB undergoes a dilation. Based on today's lesson, what will the image of the segment be?
5. Angle $\angle GHI$ measures 78° . After a dilation, what will the measure of $\angle G'H'I'$ be? How do you know?

Lesson 3: Examples of Dilations

Classwork

Example 1

Dilate circle A , from center O at the origin by scale factor $r = 3$.

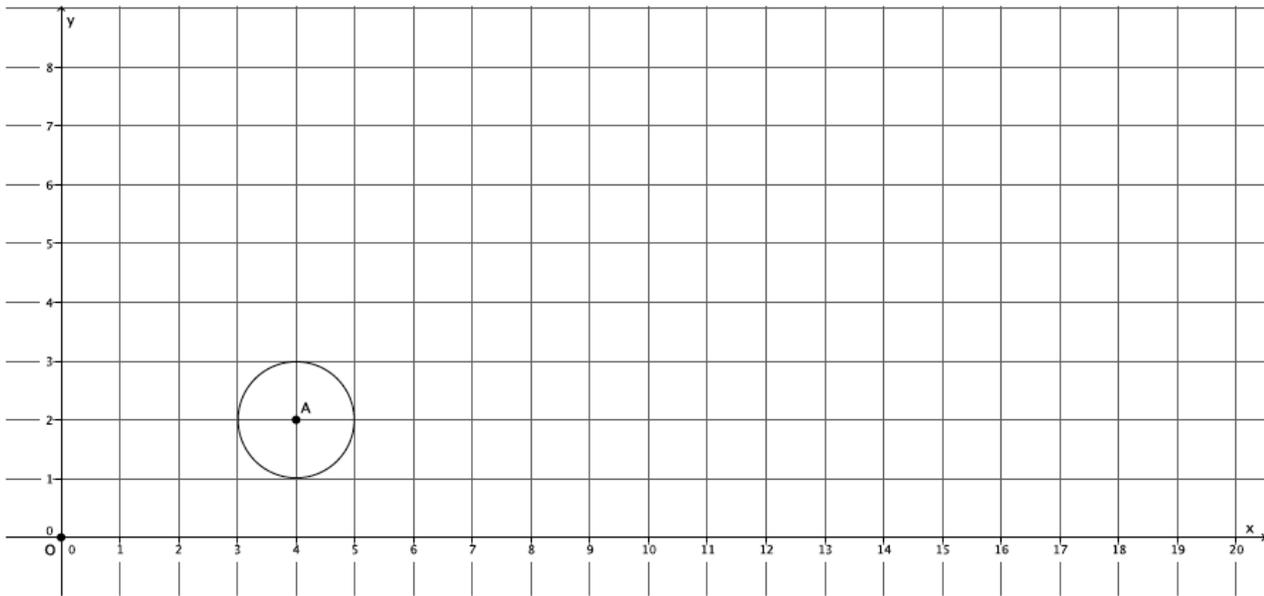

Exercises 1–2

1. Dilate ellipse E , from center O at the origin of the graph, with scale factor $r = 2$. Use as many points as necessary to develop the dilated image of ellipse E .

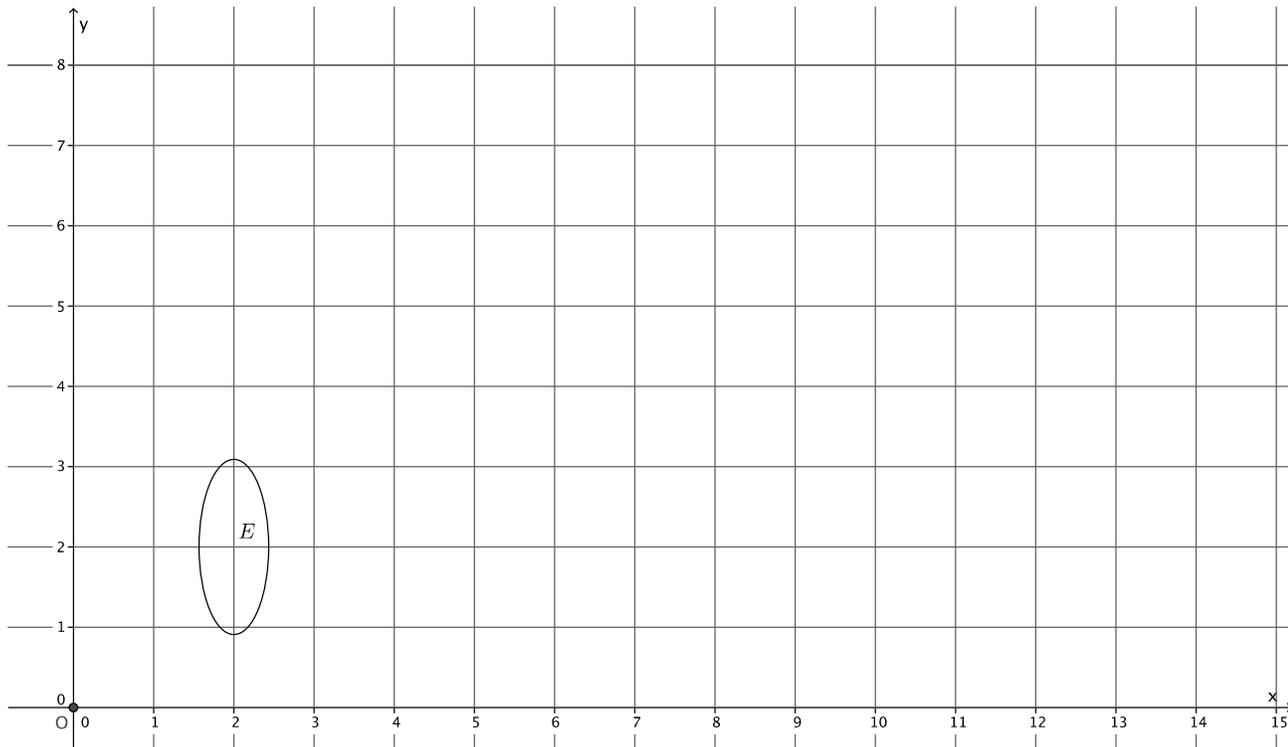

2. What shape was the dilated image?

Exercise 3

3. Triangle ABC has been dilated from center O by a scale factor of $r = \frac{1}{4}$ denoted by triangle $A'B'C'$. Using a ruler, verify that it would take a scale factor of $r = 4$ from center O to map triangle $A'B'C'$ onto triangle ABC .

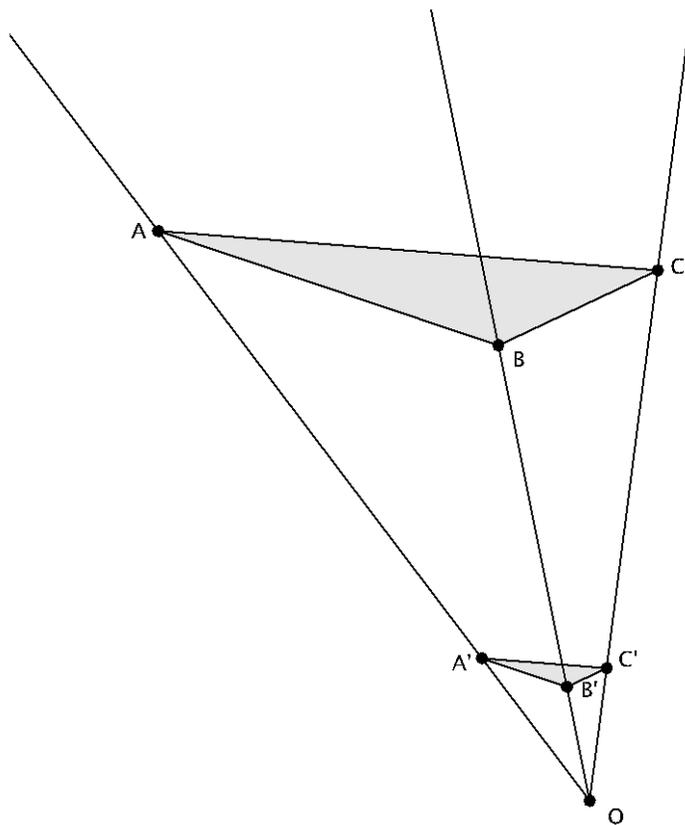

Lesson Summary

Dilations map circles to circles and ellipses to ellipses.

If a figure is dilated by scale factor r , we must dilate it by a scale factor of $\frac{1}{r}$ to bring the dilated figure back to the original size. For example, if a scale factor is $r = 4$, then to bring a dilated figure back to the original size, we must dilate it by a scale factor $r = \frac{1}{4}$.

Problem Set

1. Dilate the figure from center O by a scale factor $r = 2$. Make sure to use enough points to make a good image of the original figure.



2. Describe the process for selecting points when dilating a curved figure.
3. A triangle ABC was dilated from center O by a scale factor of $r = 5$. What scale factor would shrink the dilated figure back to the original size?
4. A figure has been dilated from center O by a scale factor of $r = \frac{7}{6}$. What scale factor would shrink the dilated figure back to the original size?
5. A figure has been dilated from center O by a scale factor of $r = \frac{3}{10}$. What scale factor would magnify the dilated figure back to the original size?

Lesson 4: Fundamental Theorem of Similarity (FTS)

Classwork

Exercise

In the diagram below, points R and S have been dilated from center O by a scale factor of $r = 3$.

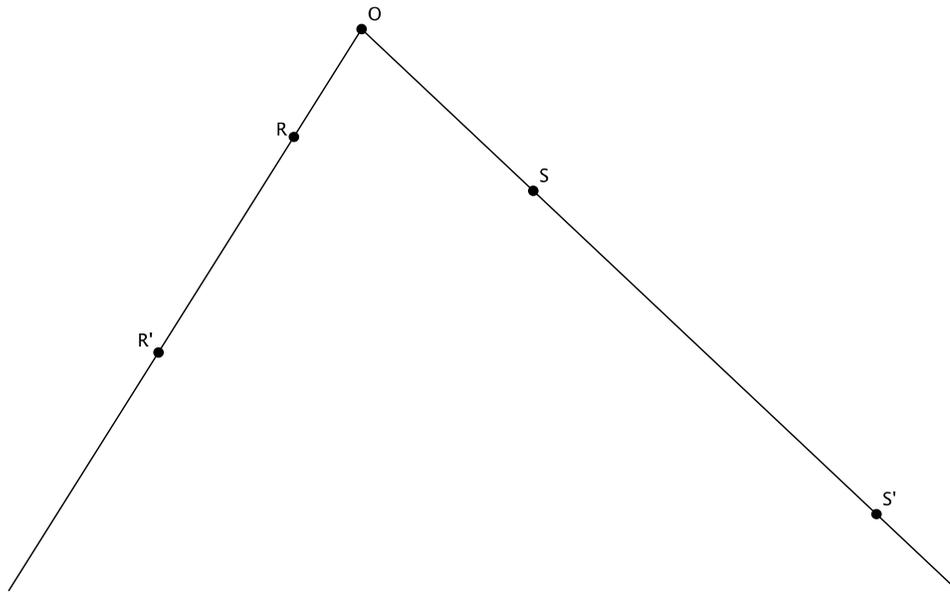

- If the length of $|OR| = 2.3$ cm, what is the length of $|OR'|$?

- If the length of $|OS| = 3.5$ cm, what is the length of $|OS'|$?

- c. Connect the point R to the point S and the point R' to the point S' . What do you know about lines RS and $R'S'$?
- d. What is the relationship between the length of segment RS and the length of segment $R'S'$?
- e. Identify pairs of angles that are equal in measure. How do you know they are equal?

Lesson Summary

Theorem: Given a dilation with center O and scale factor r , then for any two points P and Q in the plane so that O , P , and Q are not collinear, the lines PQ and $P'Q'$ are parallel, where $P' = \text{Dilation}(P)$ and $Q' = \text{Dilation}(Q)$, and furthermore, $|P'Q'| = r|PQ|$.

Problem Set

1. Use a piece of notebook paper to verify the Fundamental Theorem of Similarity for a scale factor r that is $0 < r < 1$.
 - ✓ Mark a point O on the first line of notebook paper.
 - ✓ Mark the point P on a line several lines down from the center O . Draw a ray, \overrightarrow{OP} . Mark the point P' on the ray, and on a line of the notebook paper, closer to O than you placed point P . This ensures that you have a scale factor that is $0 < r < 1$. Write your scale factor at the top of the notebook paper.
 - ✓ Draw another ray, \overrightarrow{OQ} , and mark the points Q and Q' according to your scale factor.
 - ✓ Connect points P and Q . Then, connect points P' and Q' .
 - ✓ Place a point A on line PQ between points P and Q . Draw ray \overrightarrow{OA} . Mark the point A' at the intersection of line $P'Q'$ and ray \overrightarrow{OA} .
 - a. Are lines PQ and $P'Q'$ parallel lines? How do you know?
 - b. Which, if any, of the following pairs of angles are equal in measure? Explain.
 - i. $\angle OPQ$ and $\angle OP'Q'$
 - ii. $\angle OAQ$ and $\angle OA'Q'$
 - iii. $\angle OAP$ and $\angle OA'P'$
 - iv. $\angle OQP$ and $\angle OQ'P'$
 - c. Which, if any, of the following statements are true? Show your work to verify or dispute each statement.
 - i. $|OP'| = r|OP|$
 - ii. $|OQ'| = r|OQ|$
 - iii. $|P'A'| = r|PA|$
 - iv. $|A'Q'| = r|AQ|$
 - d. Do you believe that the Fundamental Theorem of Similarity (FTS) is true even when the scale factor is $0 < r < 1$. Explain.

2. Caleb sketched the following diagram on graph paper. He dilated points B and C from center O .

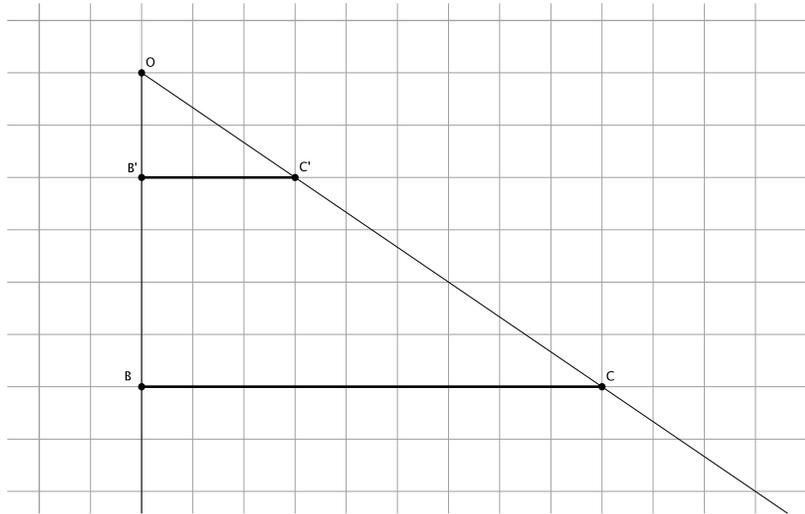

- What is the scale factor r ? Show your work.
 - Verify the scale factor with a different set of segments.
 - Which segments are parallel? How do you know?
 - Which angles are equal in measure? How do you know?
3. Points B and C were dilated from center O .

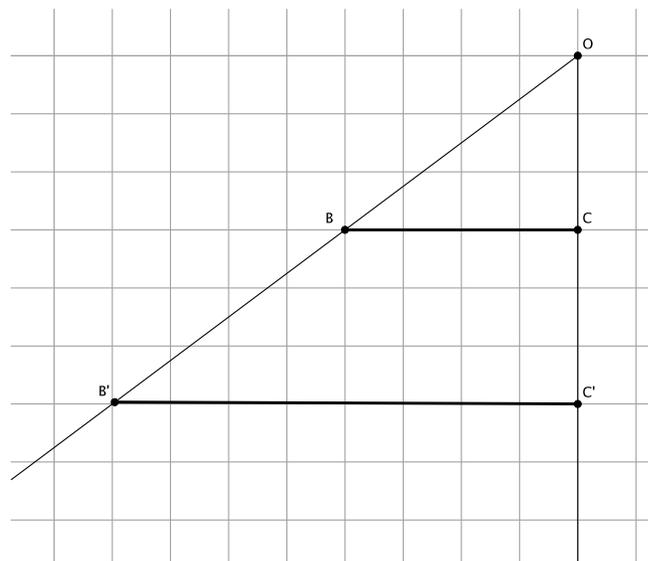

- What is the scale factor r ? Show your work.
- If the length of $|OB| = 5$, what is the length of $|OB'|$?
- How does the perimeter of triangle OBC compare to the perimeter of triangle $OB'C'$?
- Did the perimeter of triangle $OB'C' = r \times$ (perimeter of triangle OBC)? Explain.

Lesson 5: First Consequences of FTS

Classwork

Exercise 1

In the diagram below, points P and Q have been dilated from center O by scale factor r . $PQ \parallel P'Q'$, $|PQ| = 5$ cm, and $|P'Q'| = 10$ cm.

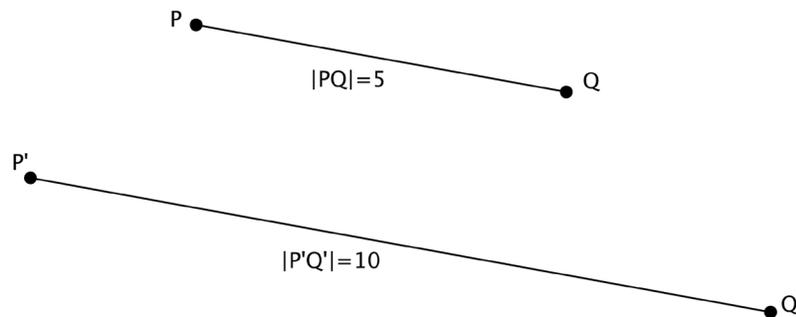

- Determine the scale factor r .
- Locate the center O of dilation. Measure the segments to verify that $|OP'| = r|OP|$ and $|OQ'| = r|OQ|$. Show your work below.

Exercise 2

In the diagram below, you are given center O and ray \overrightarrow{OA} . Point A is dilated by a scale factor $r = 4$. Use what you know about FTS to find the location of point A' .

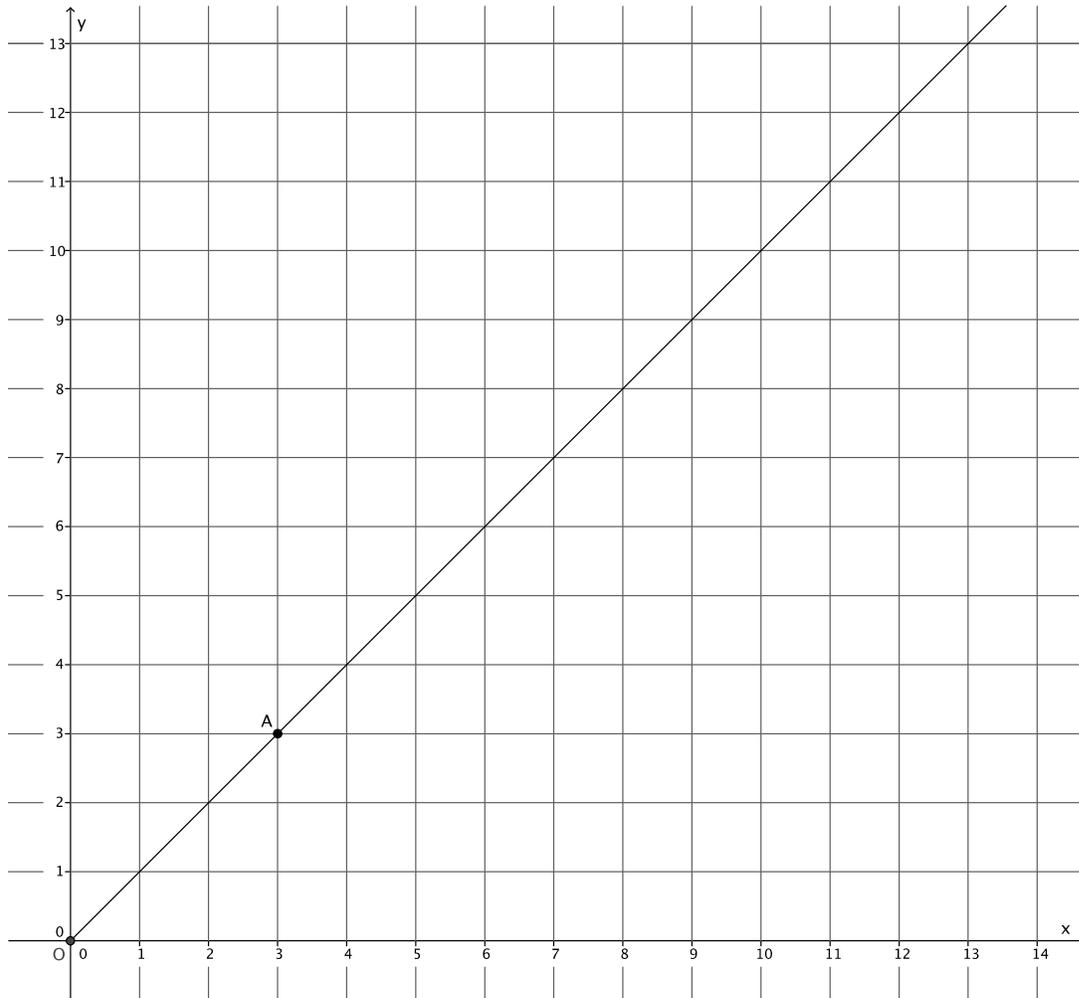

Exercise 3

In the diagram below, you are given center O and ray \overrightarrow{OA} . Point A is dilated by a scale factor $r = \frac{5}{12}$. Use what you know about FTS to find the location of point A' .

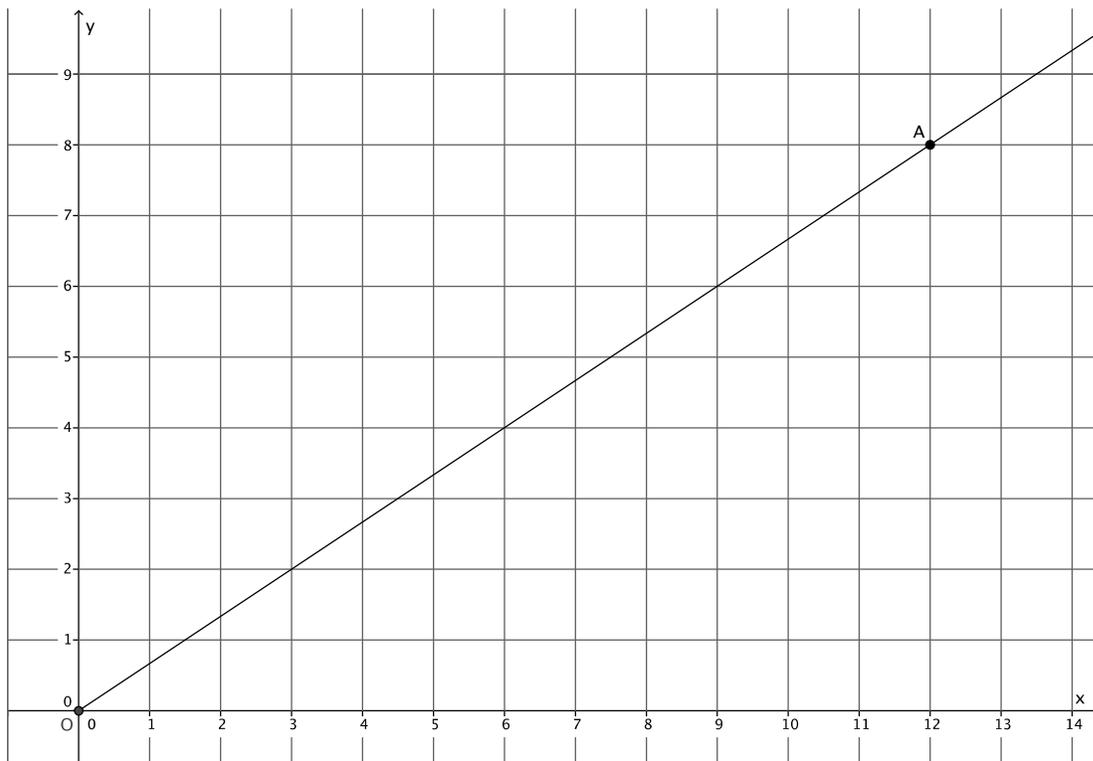

Lesson Summary

Converse of the Fundamental Theorem of Similarity:

If lines PQ and $P'Q'$ are parallel, and $|P'Q'| = r|PQ|$, then from a center O , $P' = \text{Dilation}(P)$, $Q' = \text{Dilation}(Q)$, $|OP'| = r|OP|$, and $|OQ'| = r|OQ|$.

To find the coordinates of a dilated point, we must use what we know about FTS, dilation, and scale factor.

Problem Set

1. Dilate point A , located at $(3, 4)$ from center O , by a scale factor $r = \frac{5}{3}$.

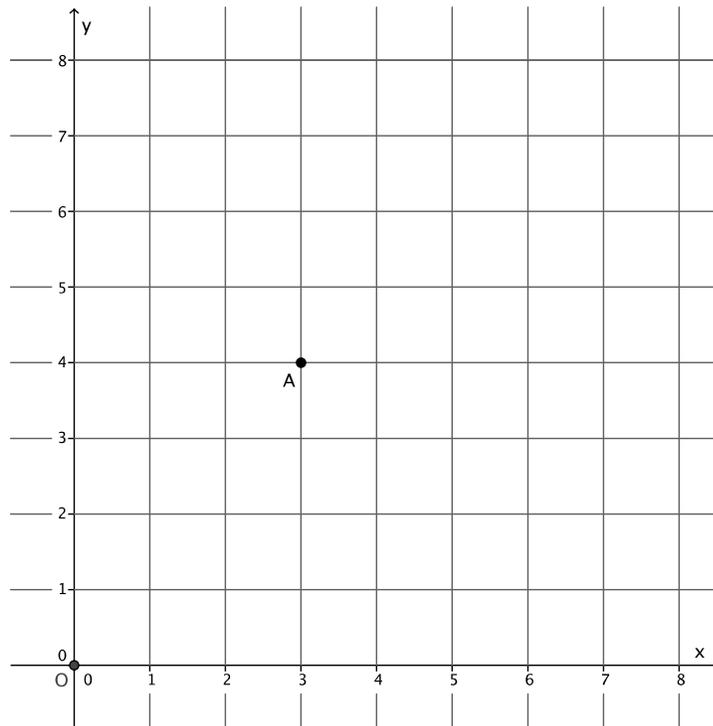

What is the precise location of point A' ?

2. Dilate point A , located at $(9, 7)$ from center O , by a scale factor $r = \frac{4}{9}$. Then dilate point B , located at $(9, 5)$ from center O , by a scale factor of $r = \frac{4}{9}$. What are the coordinates of A' and B' ? Explain.

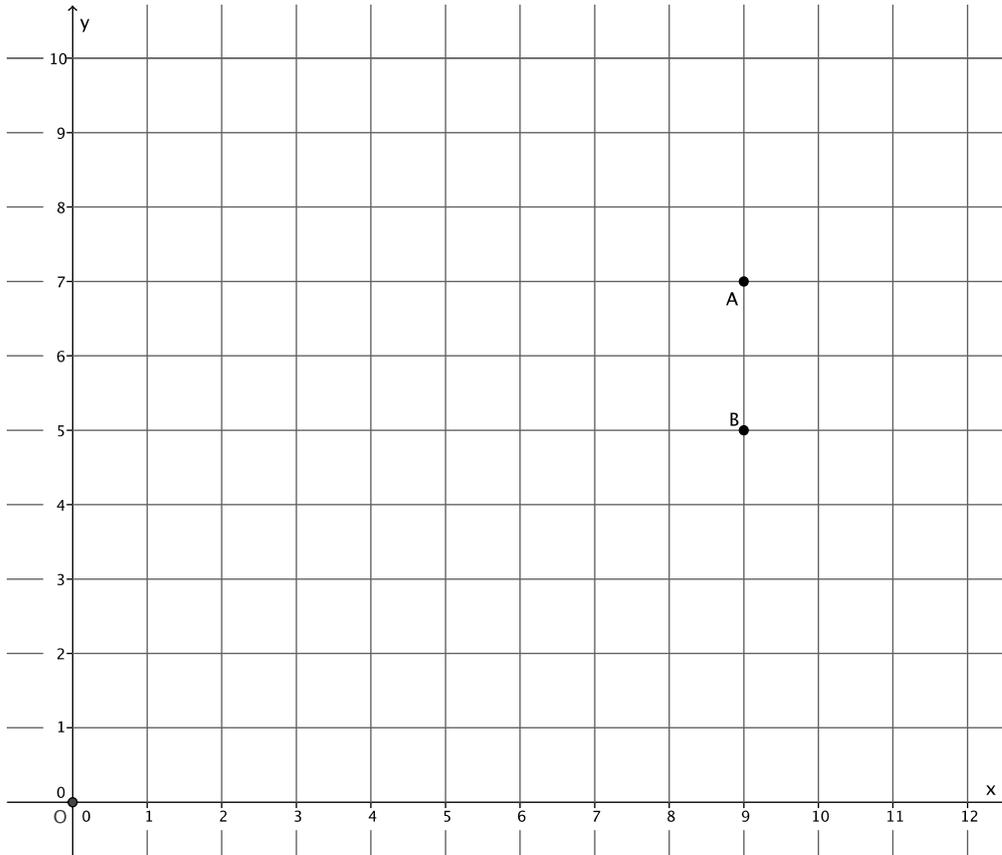

3. Explain how you used the Fundamental Theorem of Similarity in Problems 1 and 2.

Lesson 6: Dilations on the Coordinate Plane

Classwork

Exercises 1–5

1. Point $A = (7, 9)$ is dilated from the origin by scale factor $r = 6$. What are the coordinates of point A' ?
2. Point $B = (-8, 5)$ is dilated from the origin by scale factor $r = \frac{1}{2}$. What are the coordinates of point B' ?
3. Point $C = (6, -2)$ is dilated from the origin by scale factor $r = \frac{3}{4}$. What are the coordinates of point C' ?
4. Point $D = (0, 11)$ is dilated from the origin by scale factor $r = 4$. What are the coordinates of point D' ?
5. Point $E = (-2, -5)$ is dilated from the origin by scale factor $r = \frac{3}{2}$. What are the coordinates of point E' ?

Exercises 6–8

6. The coordinates of triangle ABC are shown on the coordinate plane below. The triangle is dilated from the origin by scale factor $r = 12$. Identify the coordinates of the dilated triangle $A'B'C'$.

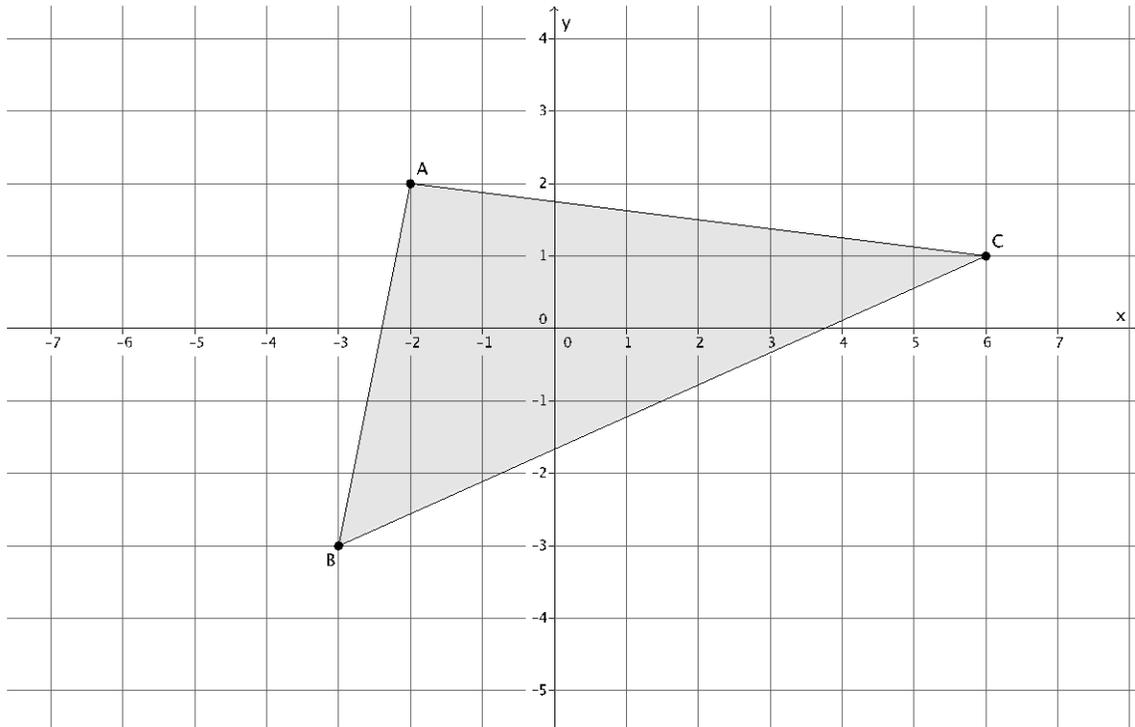

7. Figure $DEFG$ is shown on the coordinate plane below. The figure is dilated from the origin by scale factor $r = \frac{2}{3}$. Identify the coordinates of the dilated figure $D'E'F'G'$, and then draw and label figure $D'E'F'G'$ on the coordinate plane.

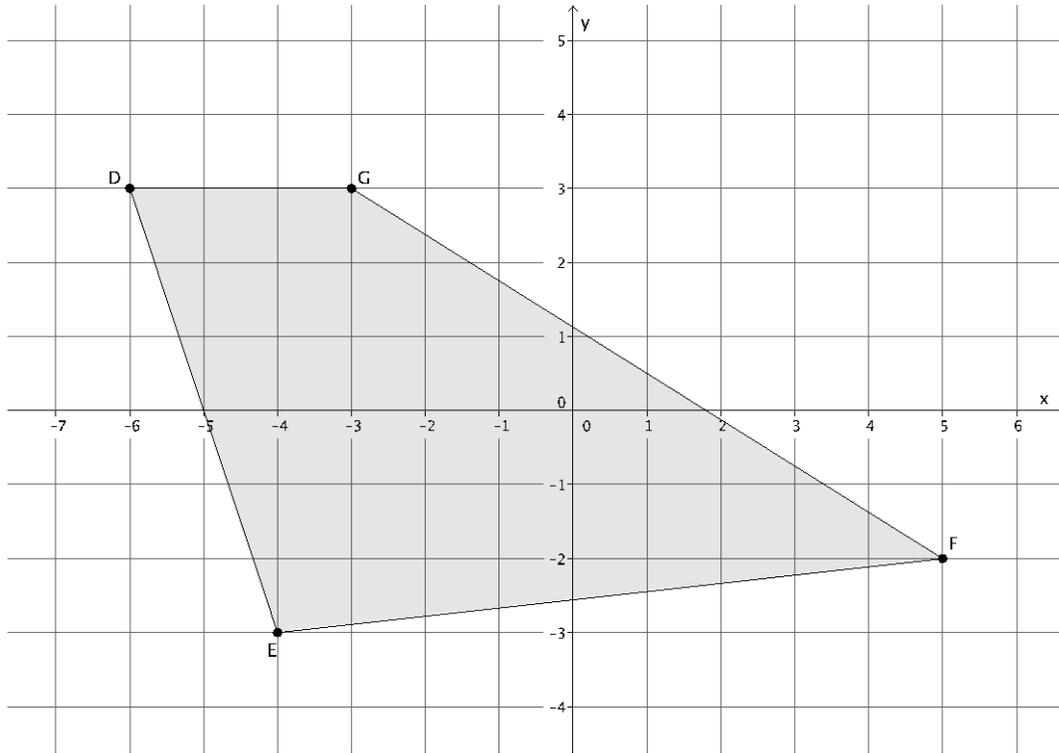

8. The triangle ABC has coordinates $A = (3, 2)$, $B = (12, 3)$, and $C = (9, 12)$. Draw and label triangle ABC on the coordinate plane. The triangle is dilated from the origin by scale factor $r = \frac{1}{3}$. Identify the coordinates of the dilated triangle $A'B'C'$, and then draw and label triangle $A'B'C'$ on the coordinate plane.

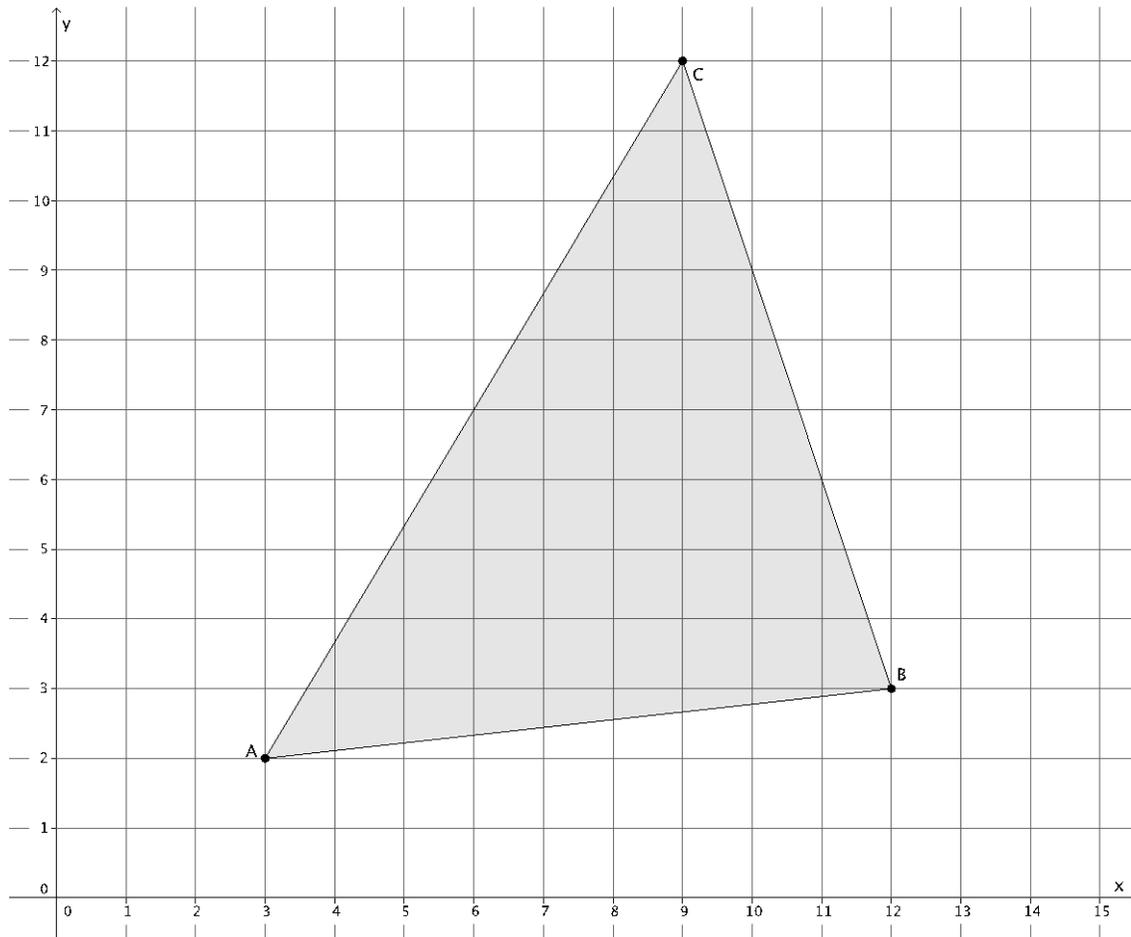

Lesson Summary

Dilation has a multiplicative effect on the coordinates of a point in the plane. Given a point (x, y) in the plane, a dilation from the origin with scale factor r moves the point (x, y) to $(r \times x, r \times y)$.

For example, if a point $(3, -5)$ in the plane is dilated from the origin by a scale factor of $r = 4$, then the coordinates of the dilated point are $(4 \times 3, 4 \times (-5)) = (12, -20)$.

Problem Set

1. Triangle ABC is shown on the coordinate plane below. The triangle is dilated from the origin by scale factor $r = 4$. Identify the coordinates of the dilated triangle $A'B'C'$.

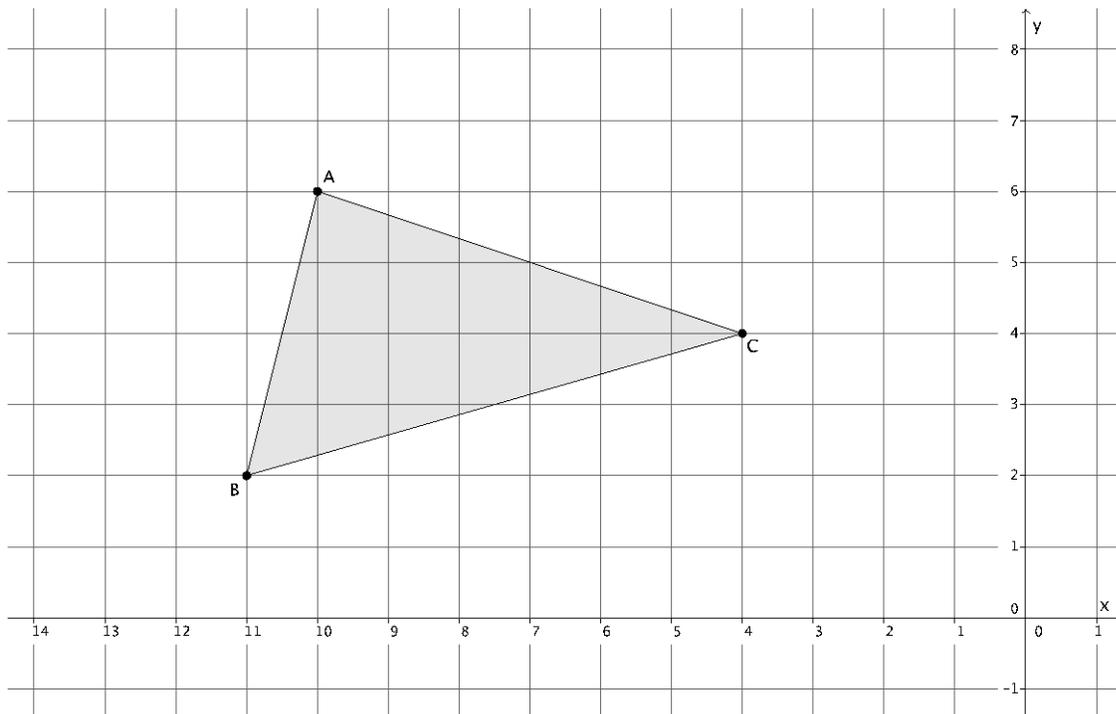

2. Triangle ABC is shown on the coordinate plane below. The triangle is dilated from the origin by scale factor $r = \frac{5}{4}$. Identify the coordinates of the dilated triangle $A'B'C'$.

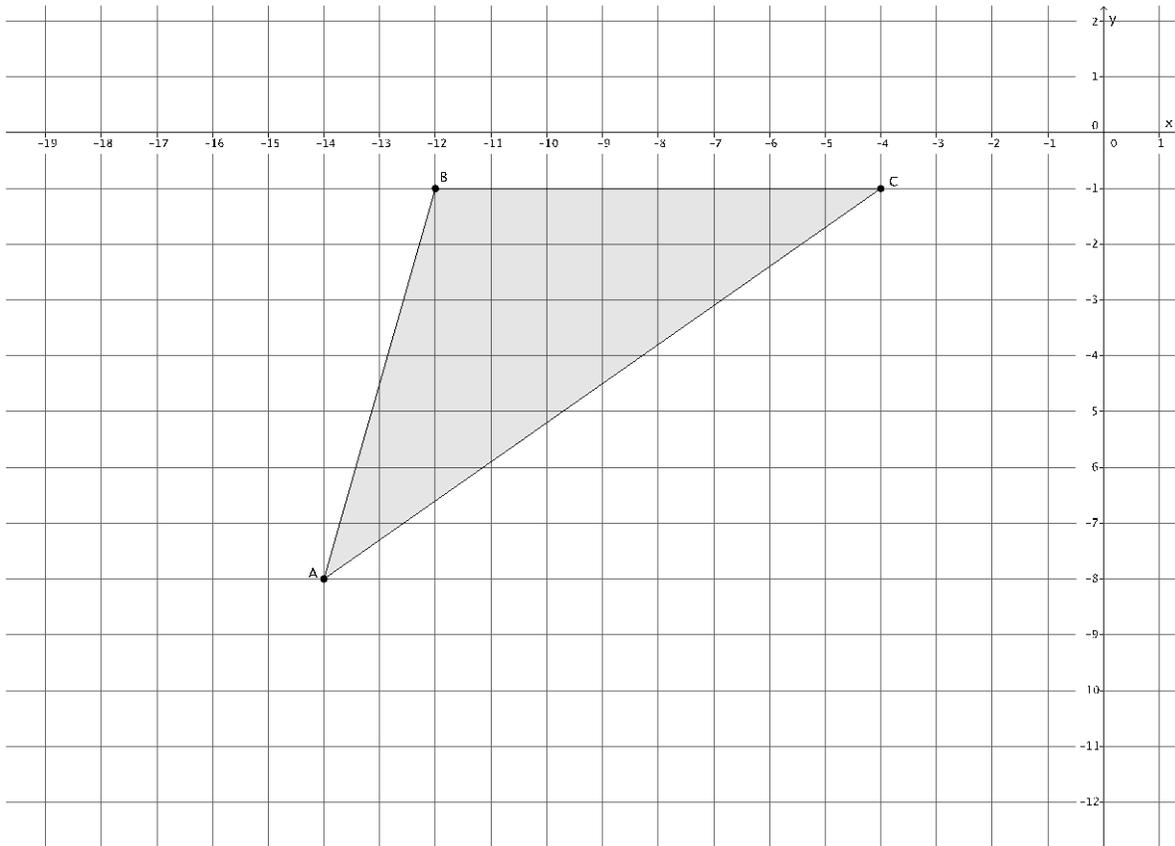

3. The triangle ABC has coordinates $A = (6, 1)$, $B = (12, 4)$, and $C = (-6, 2)$. The triangle is dilated from the origin by a scale factor $r = \frac{1}{2}$. Identify the coordinates of the dilated triangle $A'B'C'$.

4. Figure $DEFG$ is shown on the coordinate plane below. The figure is dilated from the origin by scale factor $r = \frac{3}{2}$. Identify the coordinates of the dilated figure $D'E'F'G'$, and then draw and label figure $D'E'F'G'$ on the coordinate plane.

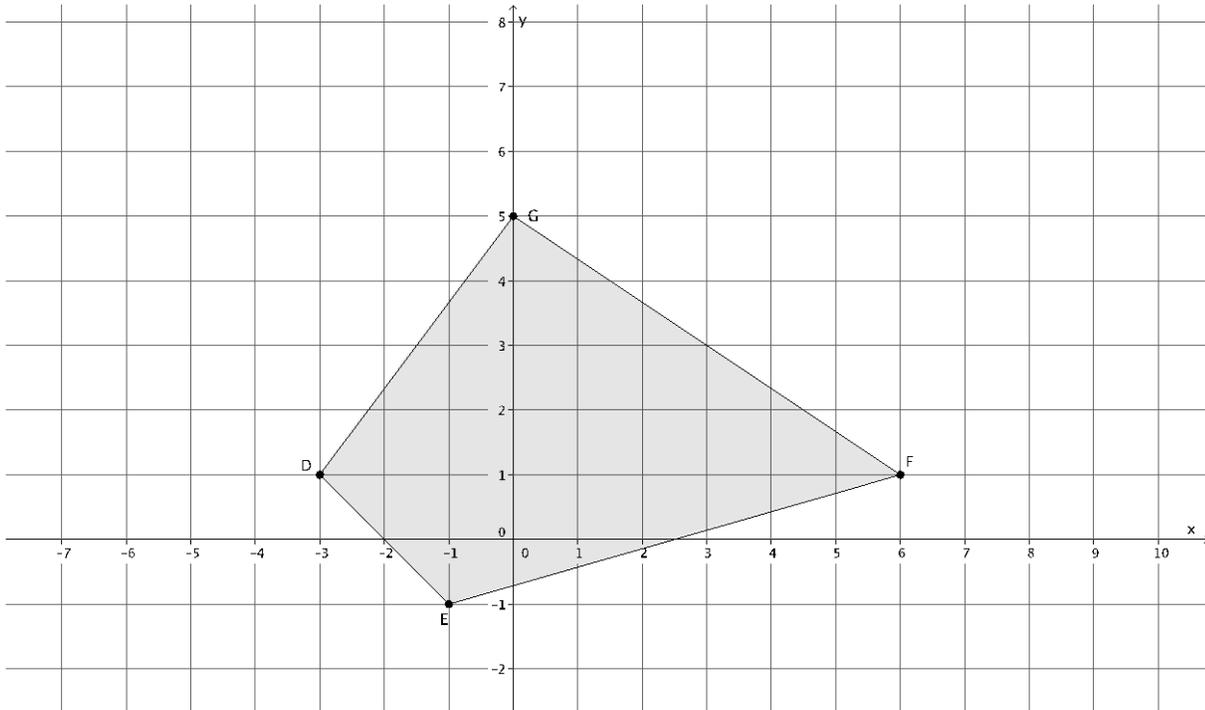

5. Figure $DEFG$ has coordinates $D = (1, 1)$, $E = (7, 3)$, $F = (5, -4)$, and $G = (-1, -4)$. The figure is dilated from the origin by scale factor $r = 7$. Identify the coordinates of the dilated figure $D'E'F'G'$.

Lesson 7: Informal Proofs of Properties of Dilation

Classwork

Exercise

Use the diagram below to prove the theorem: *Dilations preserve the measures of angles.*

Let there be a dilation from center O with scale factor r . Given $\angle PQR$, show that since $P' = \text{Dilation}(P)$, $Q' = \text{Dilation}(Q)$, and $R' = \text{Dilation}(R)$, then $|\angle PQR| = |\angle P'Q'R'|$. That is, show that the image of the angle after a dilation has the same measure, in degrees, as the original.

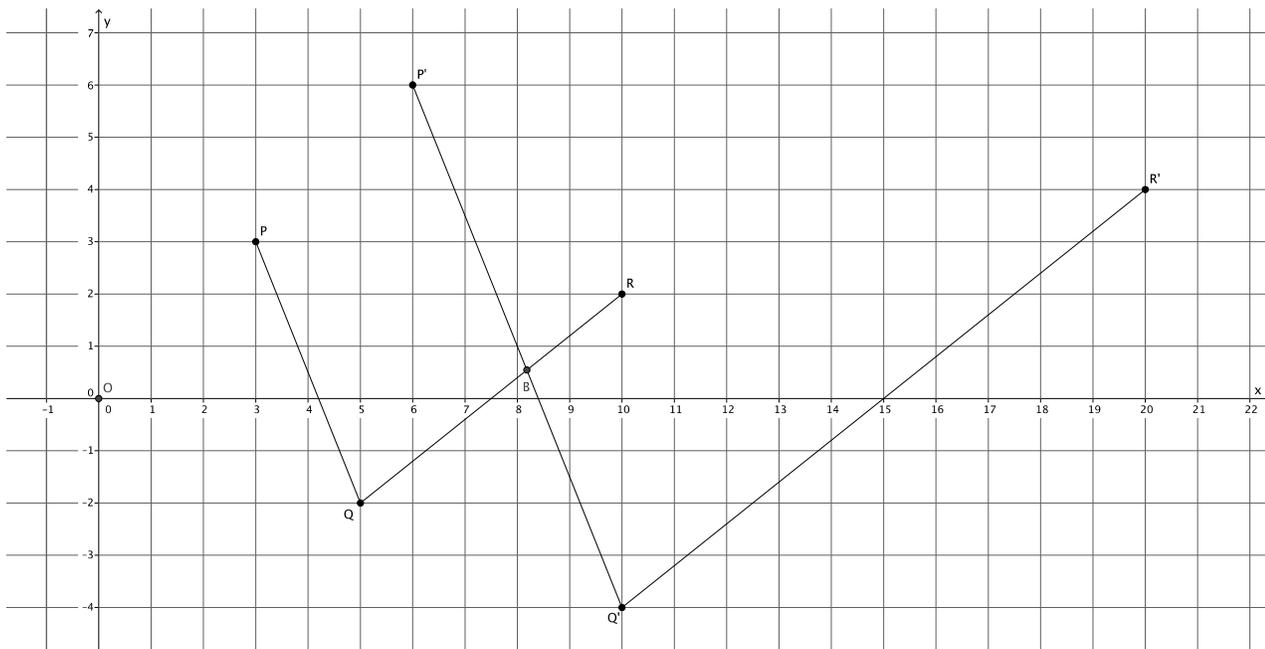

Problem Set

1. A dilation from center O by scale factor r of a line maps to what? Verify your claim on the coordinate plane.
2. A dilation from center O by scale factor r of a segment maps to what? Verify your claim on the coordinate plane.
3. A dilation from center O by scale factor r of a ray maps to what? Verify your claim on the coordinate plane.

4. Challenge Problem:

Prove the theorem: *A dilation maps lines to lines.*

Let there be a dilation from center O with scale factor r so that $P' = \text{Dilation}(P)$ and $Q' = \text{Dilation}(Q)$. Show that line PQ maps to line $P'Q'$ (i.e., that dilations map lines to lines). Draw a diagram, and then write your informal proof of the theorem. (Hint: This proof is a lot like the proof for segments. This time, let U be a point on line PQ , that is not between points P and Q .)

Lesson 8: Similarity

Classwork

Example 1

In the picture below, we have a triangle ABC that has been dilated from center O by a scale factor of $r = \frac{1}{2}$. It is noted by $A'B'C'$. We also have triangle $A''B''C''$, which is congruent to triangle $A'B'C'$ (i.e., $\triangle A'B'C' \cong \triangle A''B''C''$).

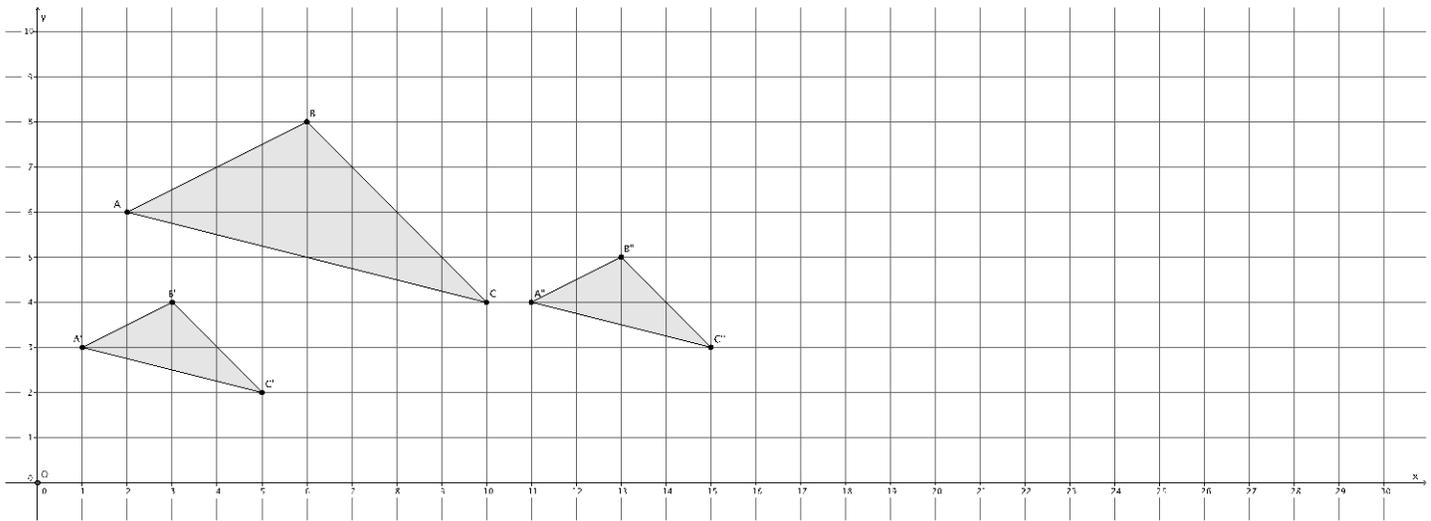

Describe the sequence that would map triangle $A''B''C''$ onto triangle ABC .

Exercises 1–4

1. Triangle ABC was dilated from center O by scale factor $r = \frac{1}{2}$. The dilated triangle is noted by $A'B'C'$. Another triangle $A''B''C''$ is congruent to triangle $A'B'C'$ (i.e., $\triangle A''B''C'' \cong \triangle A'B'C'$). Describe a dilation followed by the basic rigid motion that would map triangle $A''B''C''$ onto triangle ABC .

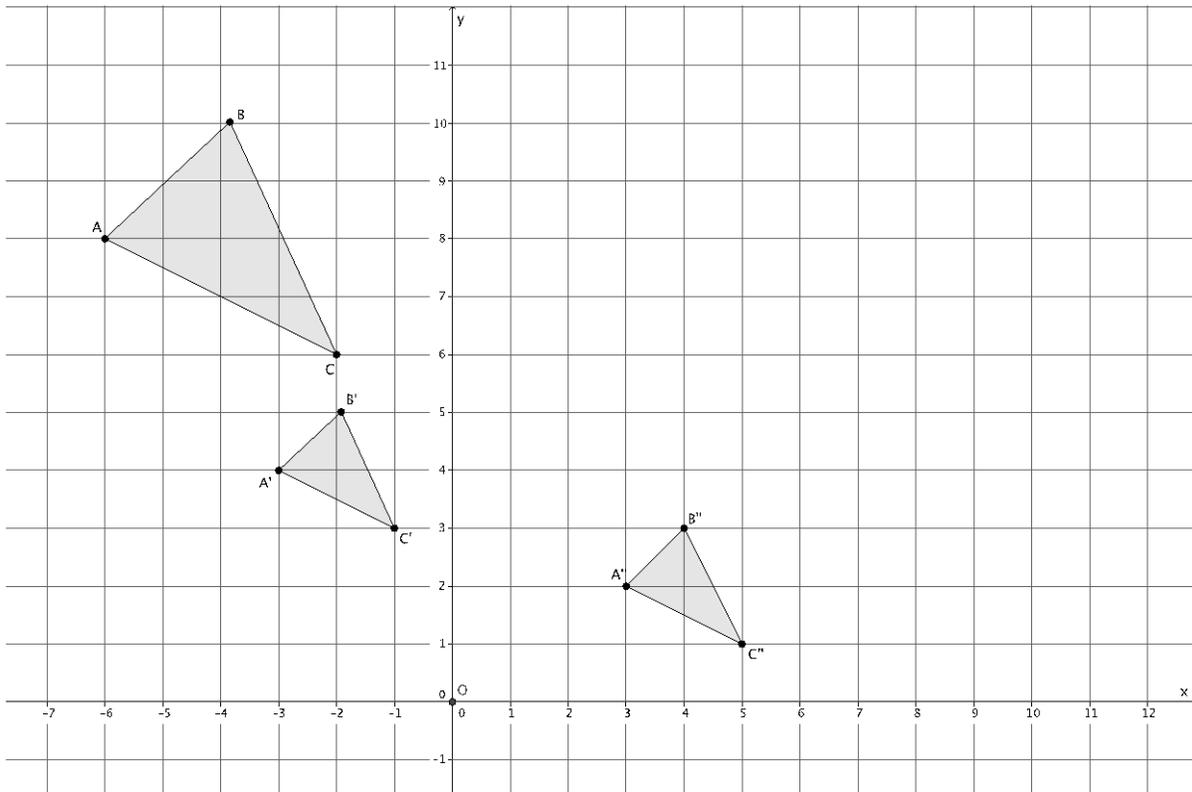

2. Describe a sequence that would show $\triangle ABC \sim \triangle A'B'C'$.

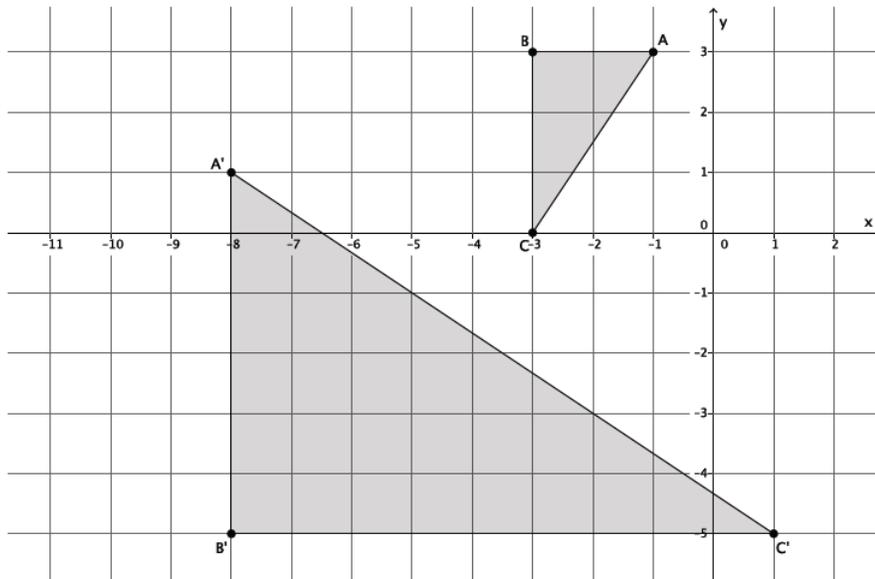

3. Are the two triangles shown below similar? If so, describe a sequence that would prove $\triangle ABC \sim \triangle A'B'C'$. If not, state how you know they are not similar.

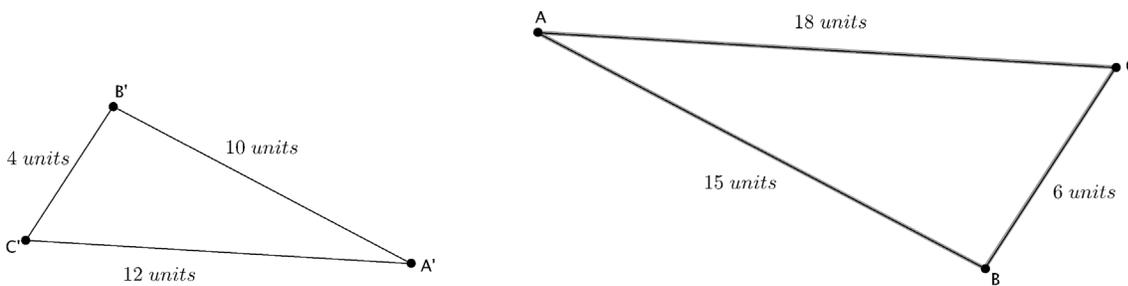

4. Are the two triangles shown below similar? If so, describe a sequence that would prove $\triangle ABC \sim \triangle A'B'C'$. If not, state how you know they are not similar.

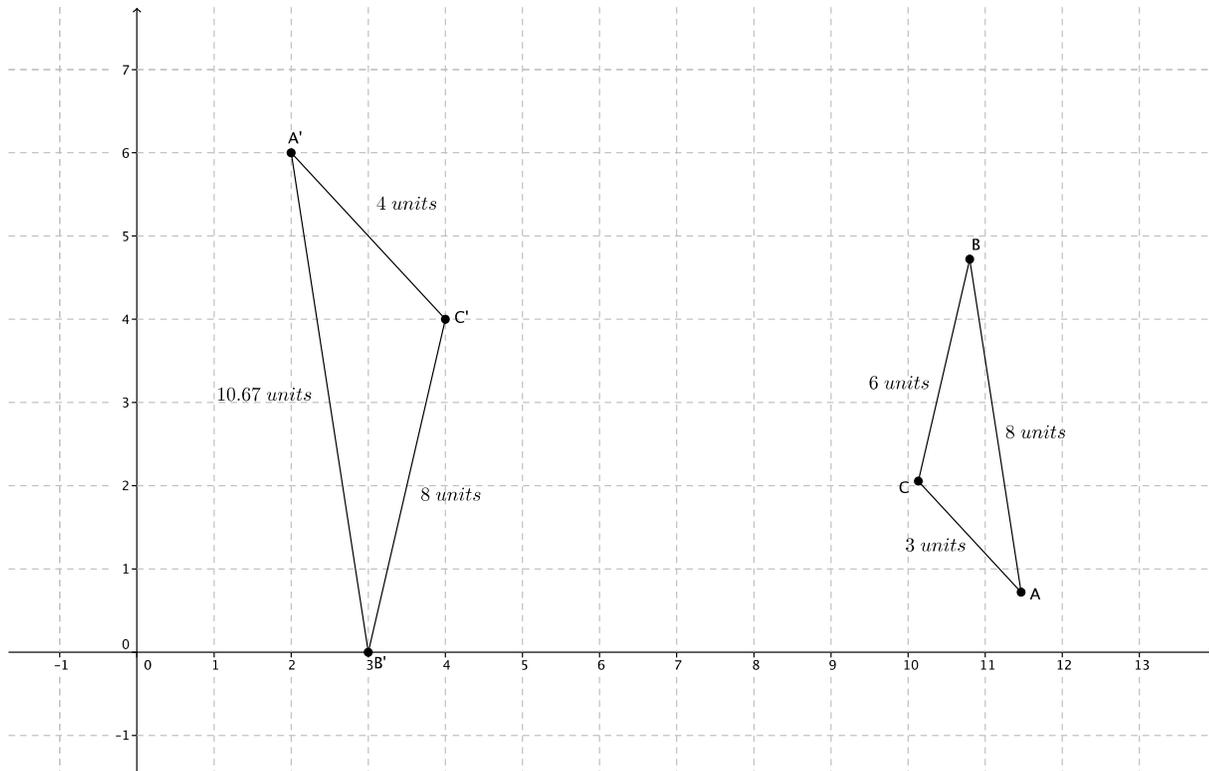

Lesson Summary

Similarity is defined as mapping one figure onto another as a sequence of a dilation followed by a congruence (a sequence of rigid motions).

The notation $\triangle ABC \sim \triangle A'B'C'$ means that $\triangle ABC$ is similar to $\triangle A'B'C'$.

Problem Set

- In the picture below, we have a triangle DEF that has been dilated from center O by scale factor $r = 4$. It is noted by $D'E'F'$. We also have a triangle $D''E''F''$, which is congruent to triangle $D'E'F'$ (i.e., $\triangle D'E'F' \cong \triangle D''E''F''$). Describe the sequence of a dilation, followed by a congruence (of one or more rigid motions) that would map triangle $D''E''F''$ onto triangle DEF .

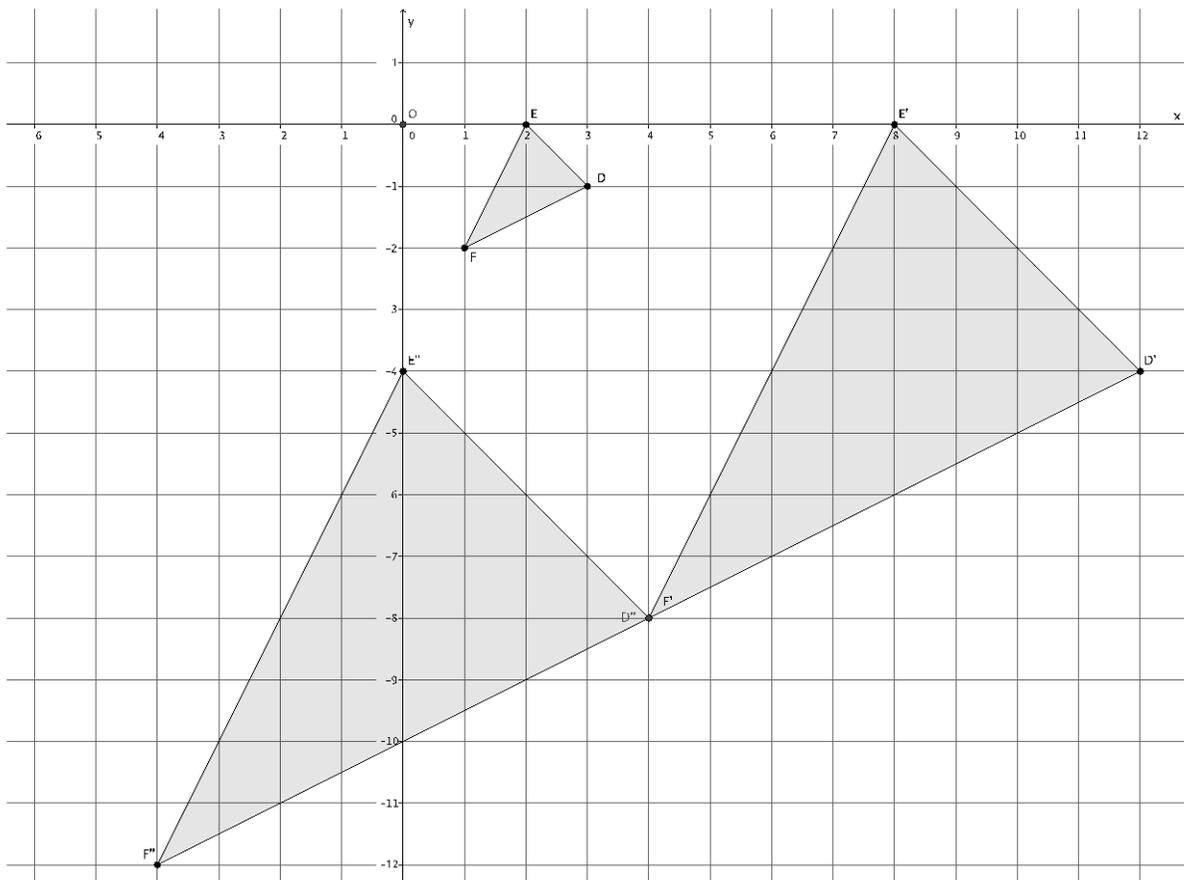

2. Triangle ABC was dilated from center O by scale factor $r = \frac{1}{2}$. The dilated triangle is noted by $A'B'C'$. Another triangle $A''B''C''$ is congruent to triangle $A'B'C'$ (i.e., $\triangle A''B''C'' \cong \triangle A'B'C'$). Describe the dilation followed by the basic rigid motions that would map triangle $A''B''C''$ onto triangle ABC .

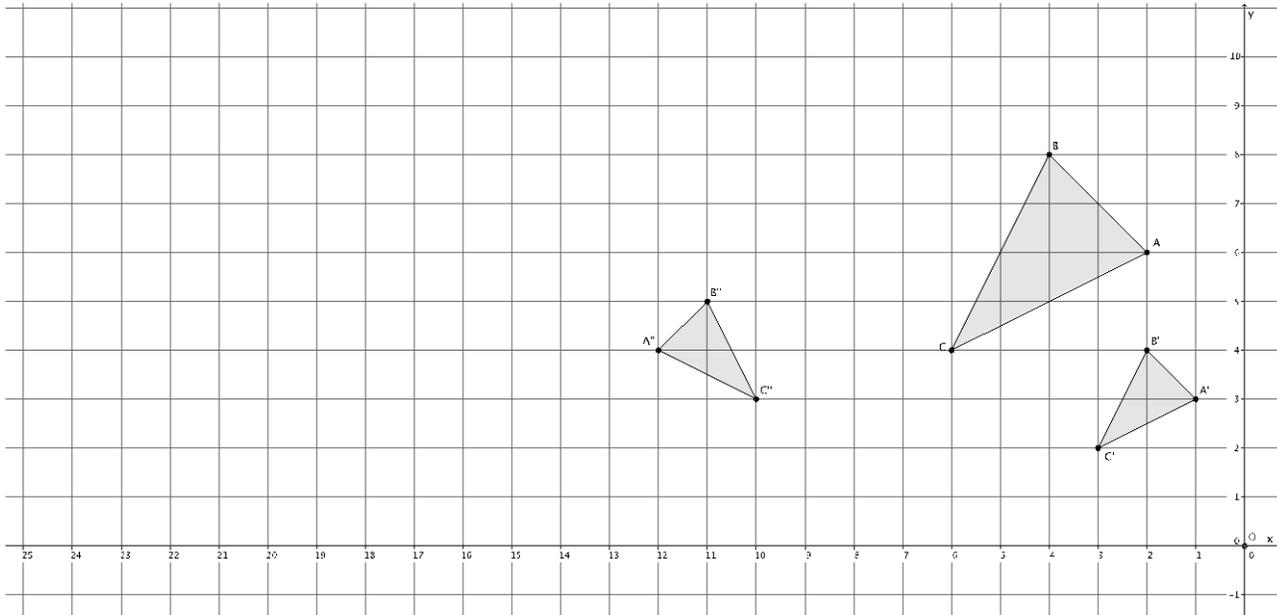

3. Are the two figures shown below similar? If so, describe a sequence that would prove the similarity. If not, state how you know they are not similar.

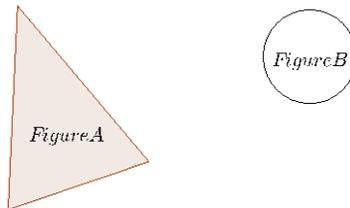

4. Triangle ABC is similar to triangle $A'B'C'$ (i.e., $\triangle ABC \sim \triangle A'B'C'$). Prove the similarity by describing a sequence that would map triangle $A'B'C'$ onto triangle ABC .

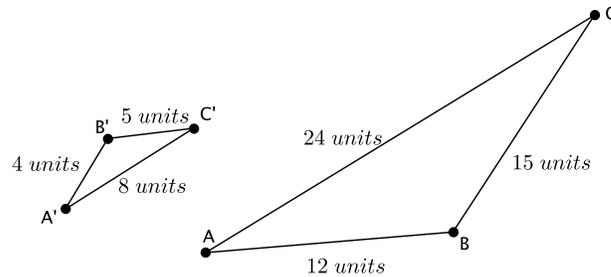

5. Are the two figures shown below similar? If so, describe a sequence that would prove $\triangle ABC \sim \triangle A'B'C'$. If not, state how you know they are not similar.

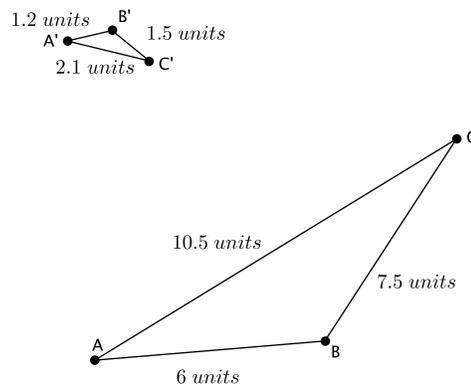

6. Describe a sequence that would show $\triangle ABC \sim \triangle A'B'C'$.

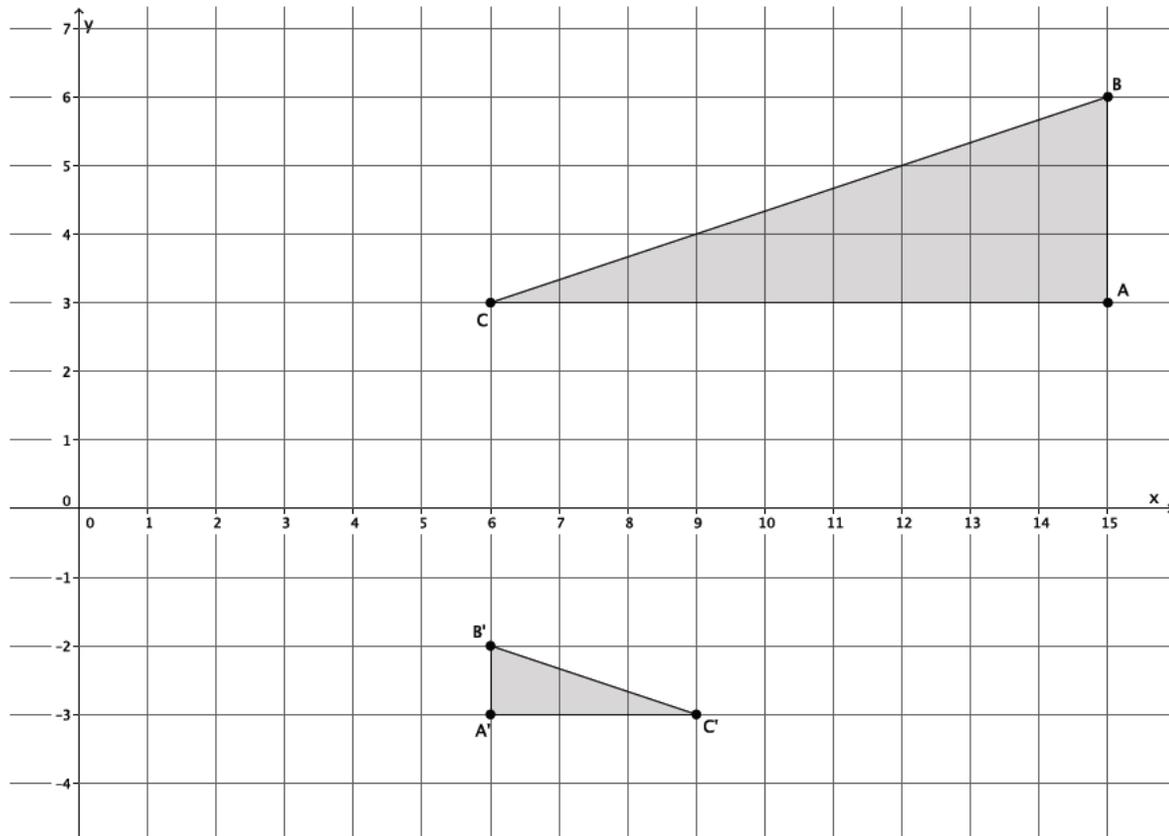

Lesson 9: Basic Properties of Similarity

Classwork

Exploratory Challenge 1

The goal is to show that if $\triangle ABC$ is similar to $\triangle A'B'C'$, then $\triangle A'B'C'$ is similar to $\triangle ABC$. Symbolically, if $\triangle ABC \sim \triangle A'B'C'$, then $\triangle A'B'C' \sim \triangle ABC$.

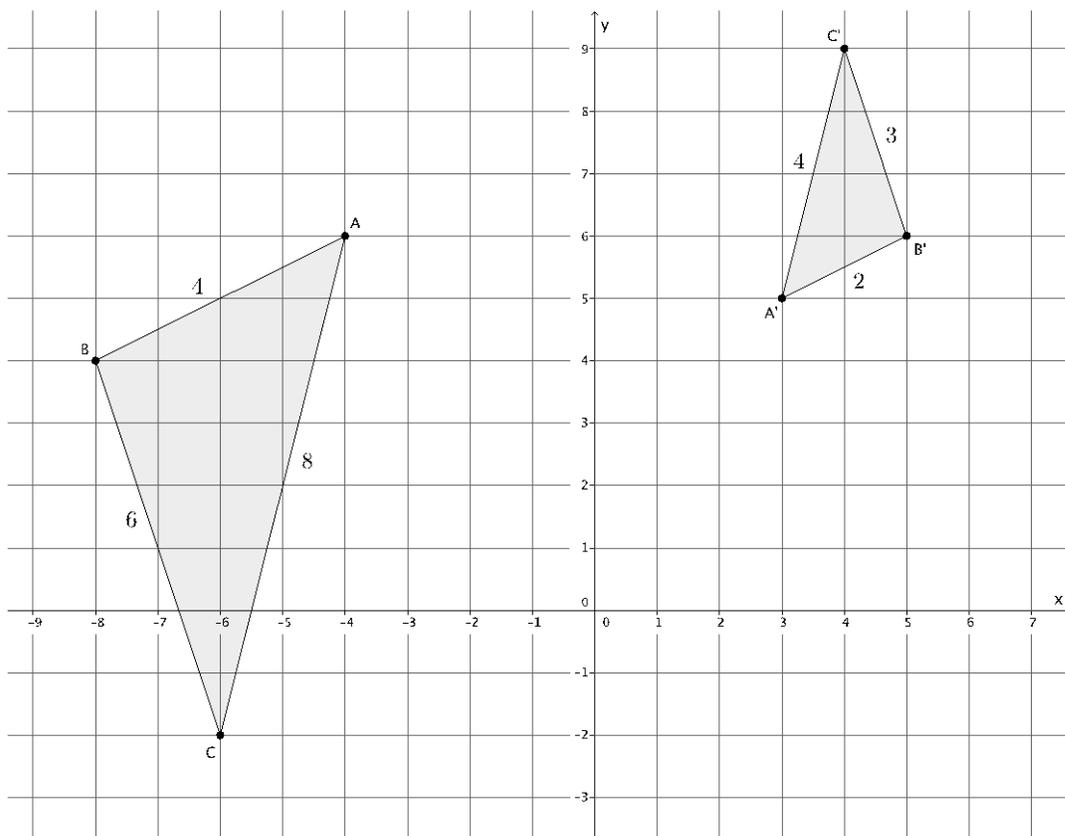

- a. First determine whether or not $\triangle ABC$ is in fact similar to $\triangle A'B'C'$. (If it isn't, then no further work needs to be done.) Use a protractor to verify that the corresponding angles are congruent and that the ratios of the corresponding sides are equal to some scale factor.

b. Describe the sequence of dilation followed by a congruence that proves $\triangle ABC \sim \triangle A'B'C'$.

c. Describe the sequence of dilation followed by a congruence that proves $\triangle A'B'C' \sim \triangle ABC$.

d. Is it true that $\triangle ABC \sim \triangle A'B'C'$ and $\triangle A'B'C' \sim \triangle ABC$? Why do you think this is so?

Exploratory Challenge 2

The goal is to show that if $\triangle ABC$ is similar to $\triangle A'B'C'$, and $\triangle A'B'C'$ is similar to $\triangle A''B''C''$, then $\triangle ABC$ is similar to $\triangle A''B''C''$. Symbolically, if $\triangle ABC \sim \triangle A'B'C'$ and $\triangle A'B'C' \sim \triangle A''B''C''$, then $\triangle ABC \sim \triangle A''B''C''$.

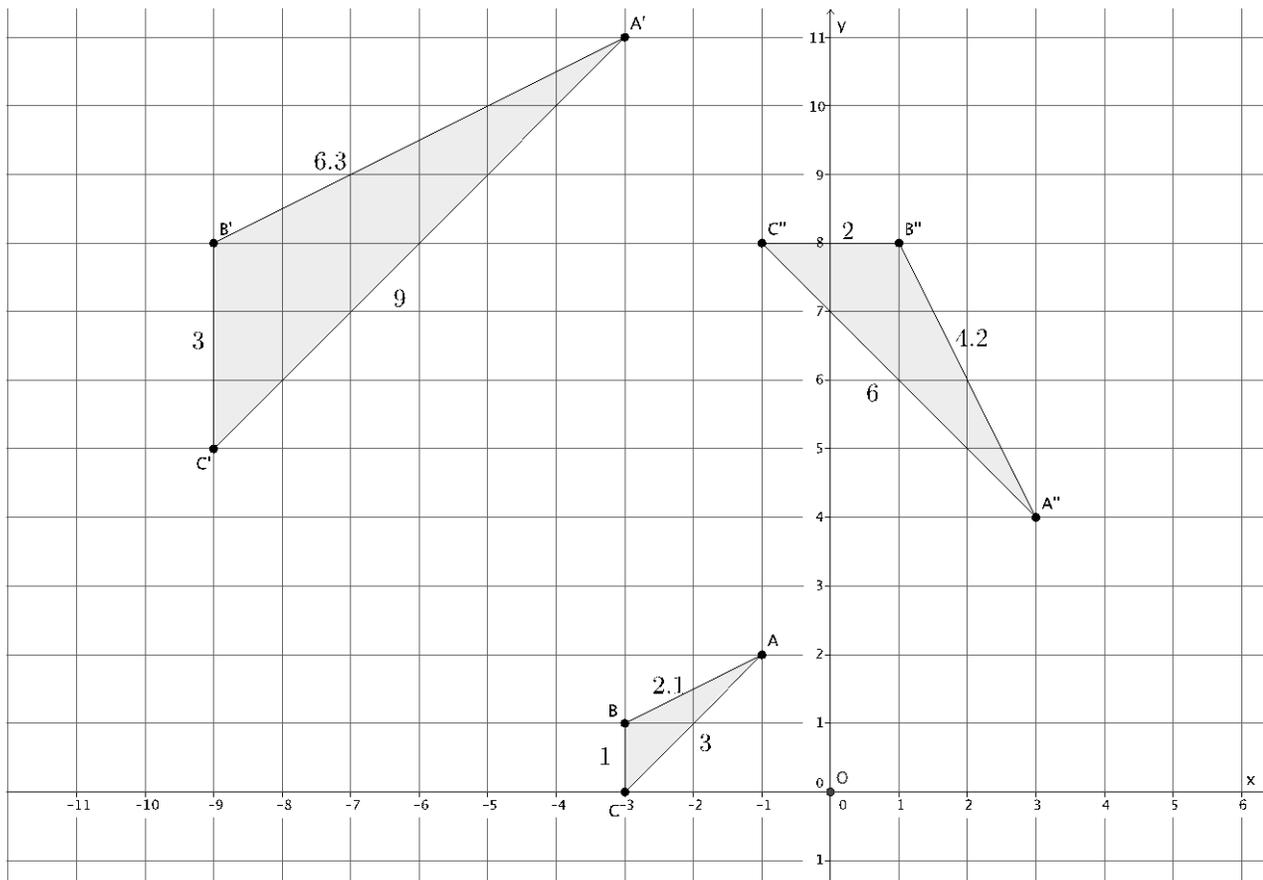

- a. Describe the similarity that proves $\triangle ABC \sim \triangle A'B'C'$.

- b. Describe the similarity that proves $\triangle A'B'C' \sim \triangle A''B''C''$.
- c. Verify that, in fact, $\triangle ABC \sim \triangle A''B''C''$ by checking corresponding angles and corresponding side lengths. Then describe the sequence that would prove the similarity $\triangle ABC \sim \triangle A''B''C''$.
- d. Is it true that if $\triangle ABC \sim \triangle A'B'C'$ and $\triangle A'B'C' \sim \triangle A''B''C''$, then $\triangle ABC \sim \triangle A''B''C''$? Why do you think this is so?

Lesson Summary

Similarity is a symmetric relation. That means that if one figure is similar to another, $S \sim S'$, then we can be sure that $S' \sim S$.

Similarity is a transitive relation. That means that if we are given two similar figures, $S \sim T$, and another statement about $T \sim U$, then we also know that $S \sim U$.

Problem Set

- Would a dilation alone be enough to show that similarity is symmetric? That is, would a dilation alone prove that if $\triangle ABC \sim \triangle A'B'C'$, then $\triangle A'B'C' \sim \triangle ABC$? Consider the two examples below.
 - Given $\triangle ABC \sim \triangle A'B'C'$. Is a dilation enough to show that $\triangle A'B'C' \sim \triangle ABC$? Explain.

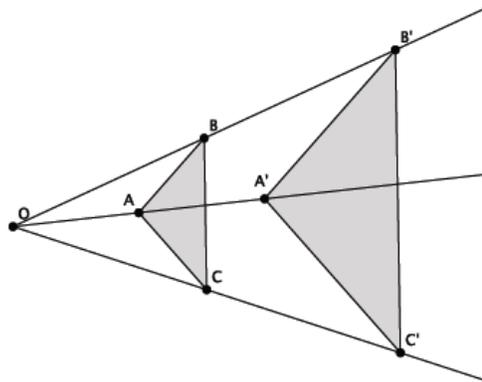

- Given $\triangle ABC \sim \triangle A'B'C'$. Is a dilation enough to show that $\triangle A'B'C' \sim \triangle ABC$? Explain.

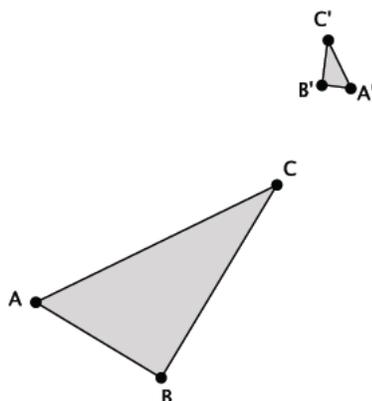

- In general, is dilation enough to prove that similarity is a symmetric relation? Explain.

2. Would a dilation alone be enough to show that similarity is transitive? That is, would a dilation alone prove that if $\triangle ABC \sim \triangle A'B'C'$, and $\triangle A'B'C' \sim \triangle A''B''C''$, then $\triangle ABC \sim \triangle A''B''C''$? Consider the two examples below.
- a. Given $\triangle ABC \sim \triangle A'B'C'$ and $\triangle A'B'C' \sim \triangle A''B''C''$. Is a dilation enough to show that $\triangle ABC \sim \triangle A''B''C''$? Explain.

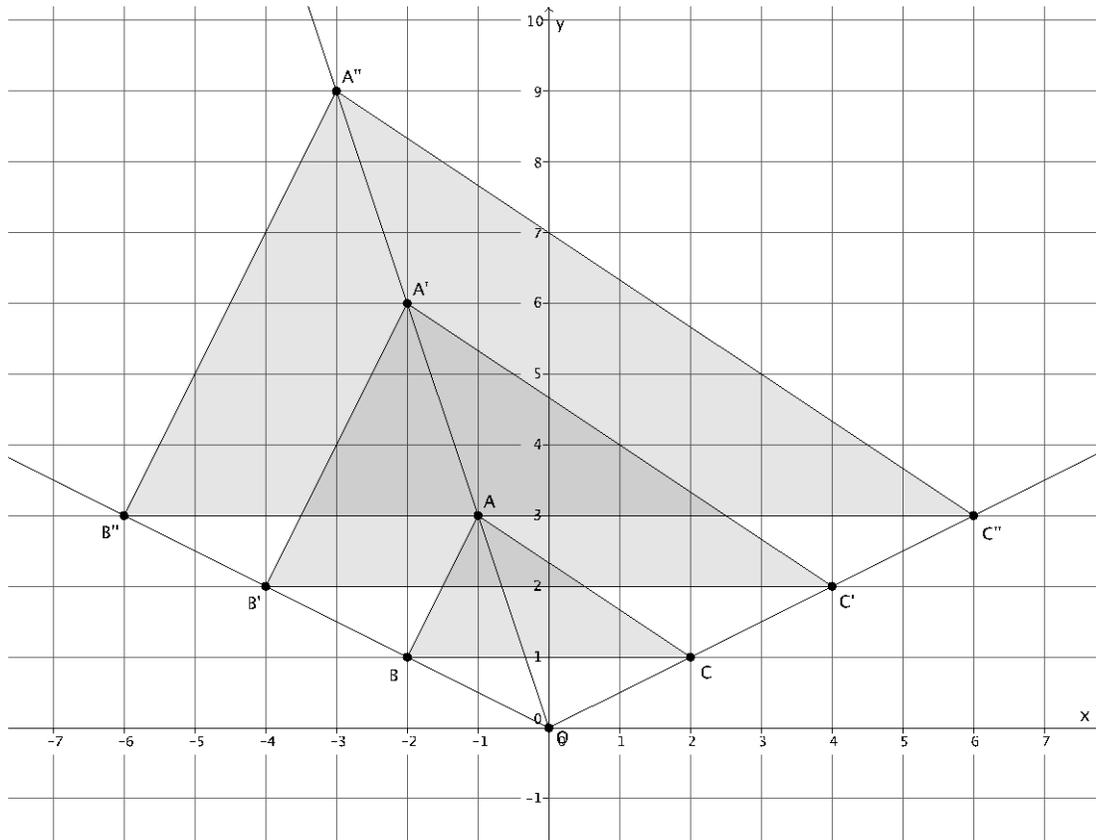

- b. Given $\triangle ABC \sim \triangle A'B'C'$ and $\triangle A'B'C' \sim \triangle A''B''C''$. Is a dilation enough to show that $\triangle ABC \sim \triangle A''B''C''$? Explain.

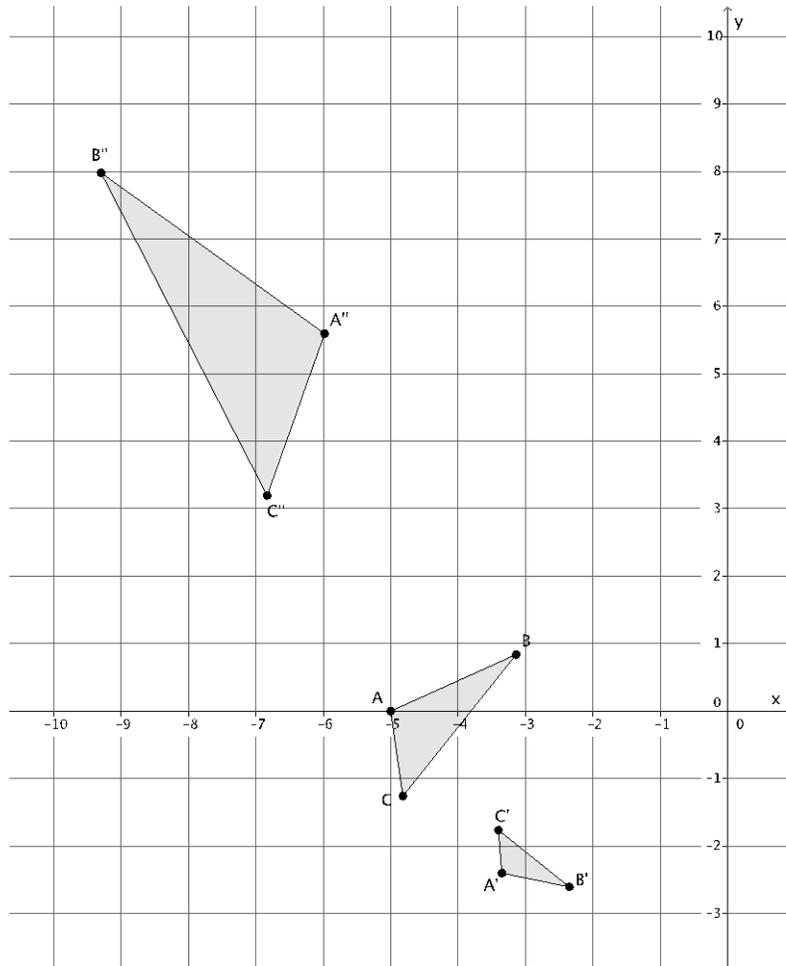

- c. In general, is dilation enough to prove that similarity is a transitive relation? Explain.

3. In the diagram below, $\triangle ABC \sim \triangle A'B'C'$ and $\triangle A'B'C' \sim \triangle A''B''C''$. Is $\triangle ABC \sim \triangle A''B''C''$? If so, describe the dilation followed by the congruence that demonstrates the similarity.

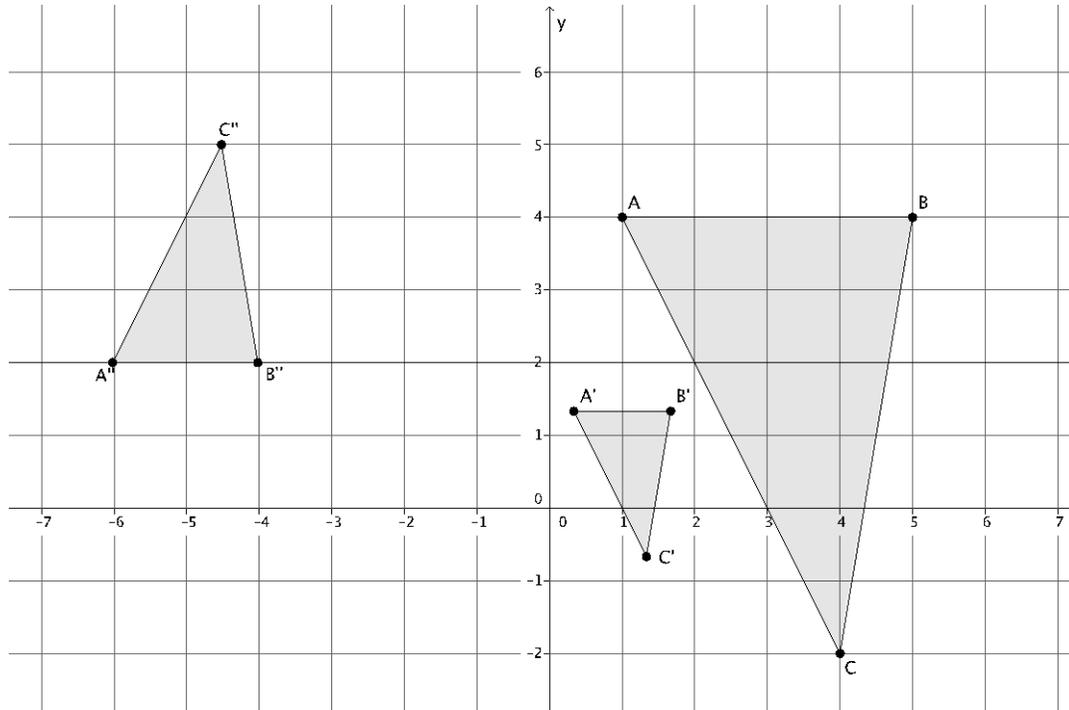

3. Are the triangles shown below similar? Present an informal argument as to why they are or are not similar.

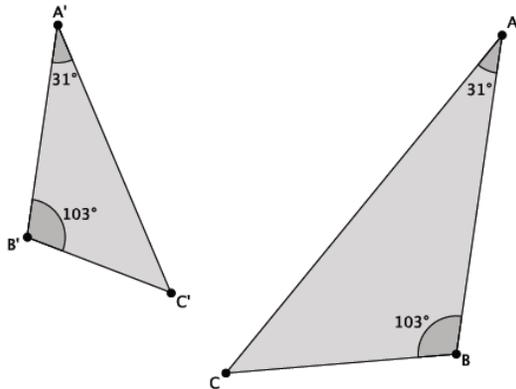

4. Are the triangles shown below similar? Present an informal argument as to why they are or are not similar.

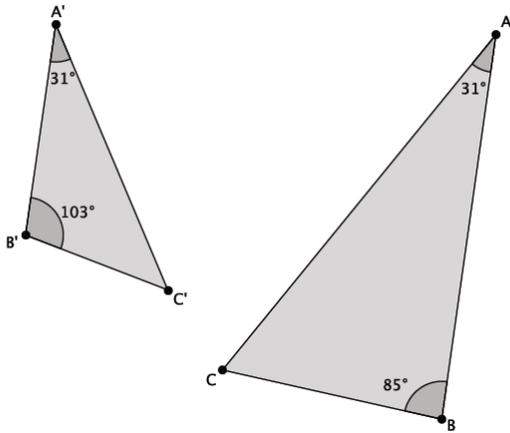

5. Are the triangles shown below similar? Present an informal argument as to why they are or are not similar.

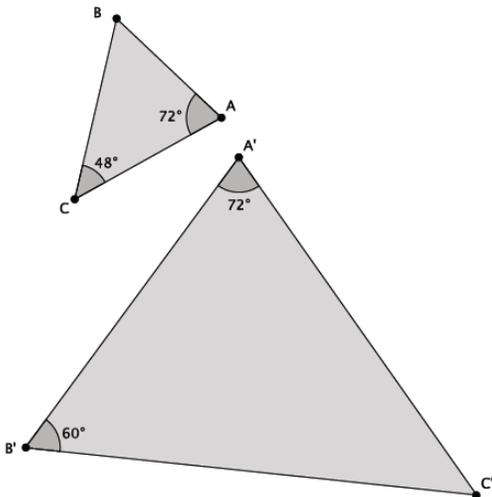

Lesson Summary

Two triangles are said to be similar if they have two pairs of corresponding angles that are equal in measure.

Problem Set

1. Are the triangles shown below similar? Present an informal argument as to why they are or are not similar.

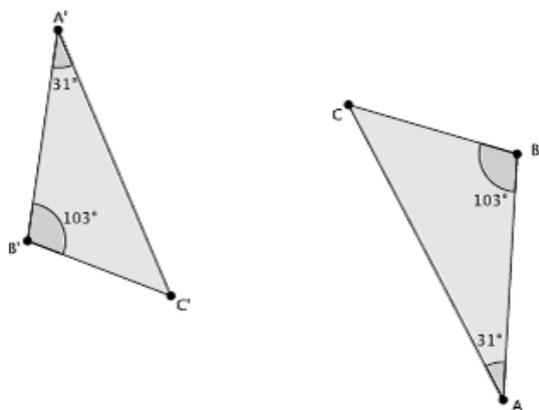

2. Are the triangles shown below similar? Present an informal argument as to why they are or are not similar.

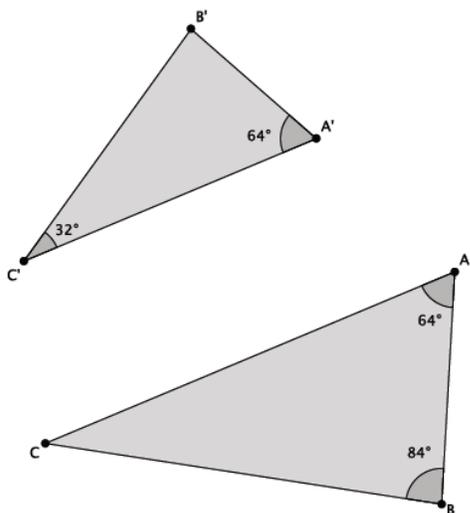

3. Are the triangles shown below similar? Present an informal argument as to why they are or are not similar.

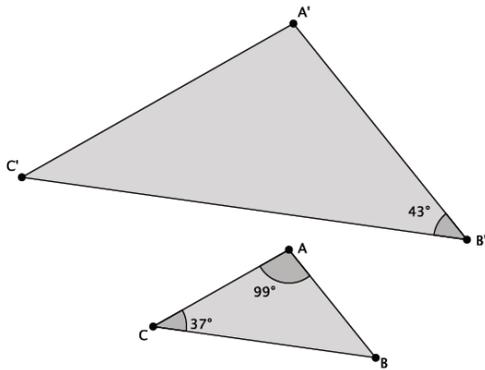

4. Are the triangles shown below similar? Present an informal argument as to why they are or are not similar.

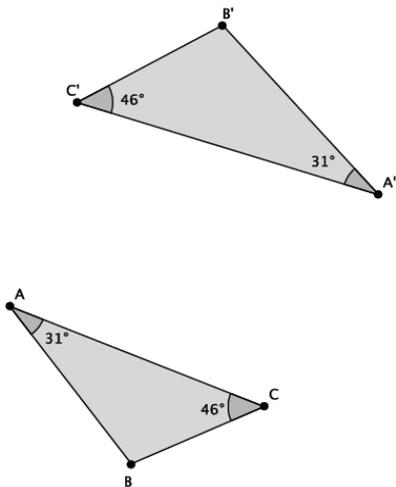

5. Are the triangles shown below similar? Present an informal argument as to why they are or are not similar.

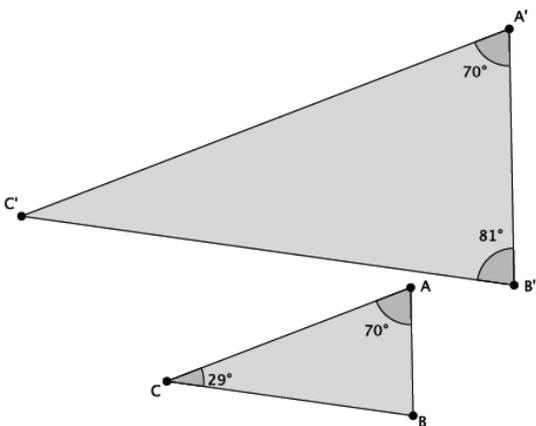

6. Are the triangles shown below similar? Present an informal argument as to why they are or are not similar.

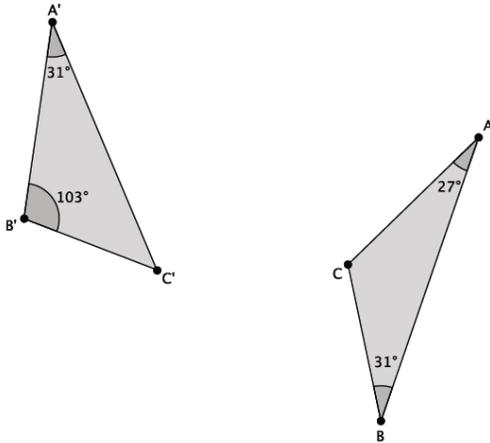

7. Are the triangles shown below similar? Present an informal argument as to why they are or are not similar.

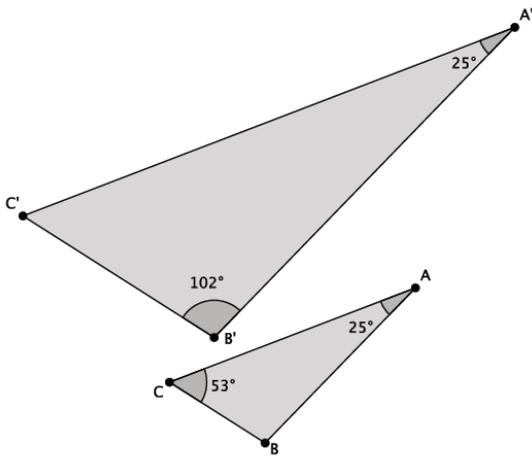

Lesson 11: More About Similar Triangles

Classwork

Exercises

1. In the diagram below, you have $\triangle ABC$ and $\triangle AB'C'$. Use this information to answer parts (a)–(d).

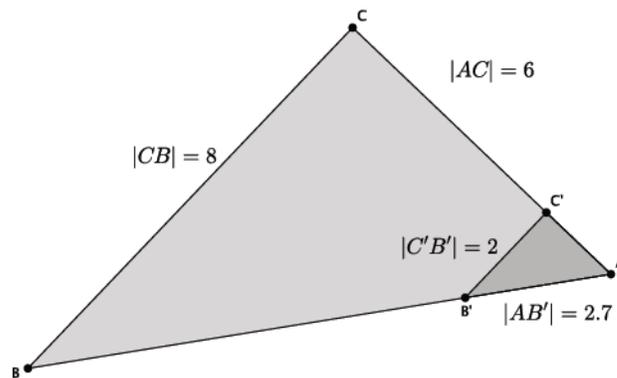

- a. Based on the information given, is $\triangle ABC \sim \triangle AB'C'$? Explain.
- b. Assume line BC is parallel to line $B'C'$. With this information, can you say that $\triangle ABC \sim \triangle AB'C'$? Explain.
- c. Given that $\triangle ABC \sim \triangle AB'C'$, determine the length of side AC' .
- d. Given that $\triangle ABC \sim \triangle AB'C'$, determine the length of side AB .

2. In the diagram below, you have $\triangle ABC$ and $\triangle A'B'C'$. Use this information to answer parts (a)–(c).

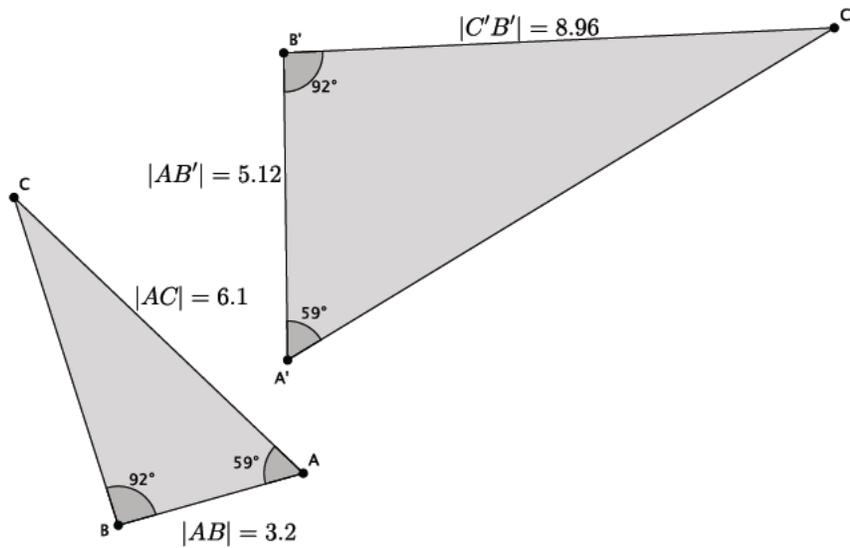

- a. Based on the information given, is $\triangle ABC \sim \triangle A'B'C'$? Explain.
- b. Given that $\triangle ABC \sim \triangle A'B'C'$, determine the length of side $A'C'$.
- c. Given that $\triangle ABC \sim \triangle A'B'C'$, determine the length of side BC .

3. In the diagram below, you have $\triangle ABC$ and $\triangle A'B'C'$. Use this information to answer the question below.

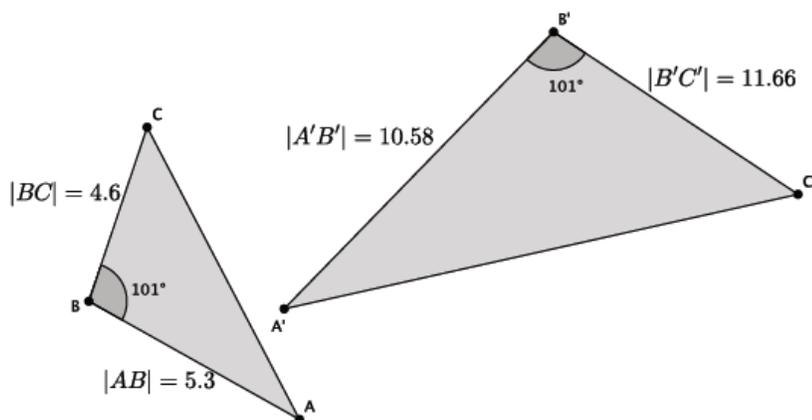

Based on the information given, is $\triangle ABC \sim \triangle A'B'C'$? Explain.

Lesson Summary

Given just one pair of corresponding angles of a triangle as equal, use the side lengths along the given angle to determine if triangles are in fact similar.

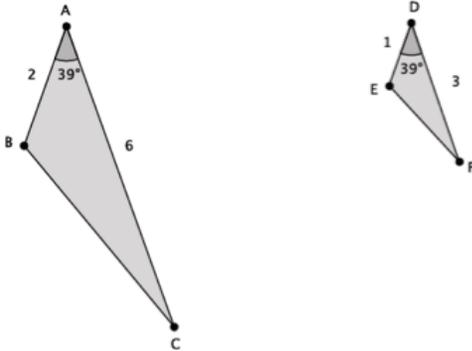

$$|\angle A| = |\angle D| \text{ and } \frac{1}{2} = \frac{3}{6} = r; \text{ therefore, } \triangle ABC \sim \triangle DEF.$$

Given similar triangles, use the fact that ratios of corresponding sides are equal to find any missing measurements.

Problem Set

1. In the diagram below, you have $\triangle ABC$ and $\triangle A'B'C'$. Use this information to answer parts (a)–(b).

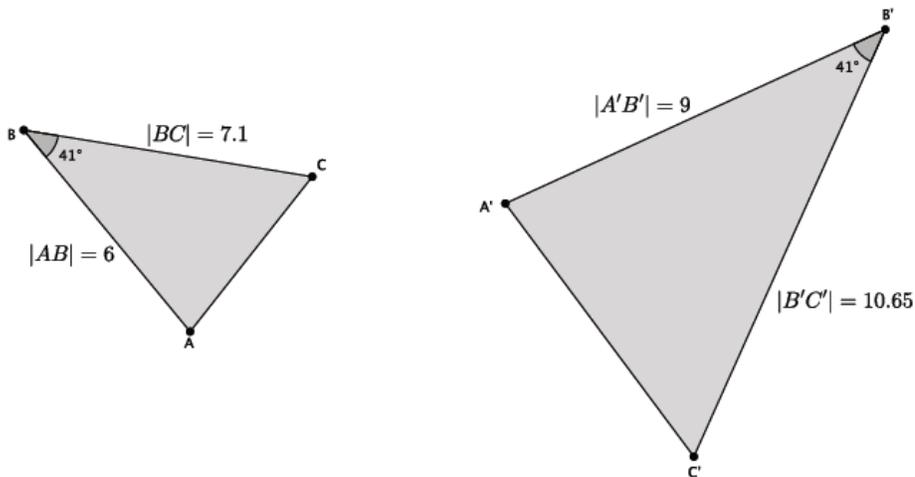

- Based on the information given, is $\triangle ABC \sim \triangle A'B'C'$? Explain.
- Assume the length of side AC is 4.3. What is the length of side $A'C'$?

2. In the diagram below, you have $\triangle ABC$ and $\triangle AB'C'$. Use this information to answer parts (a)–(d).

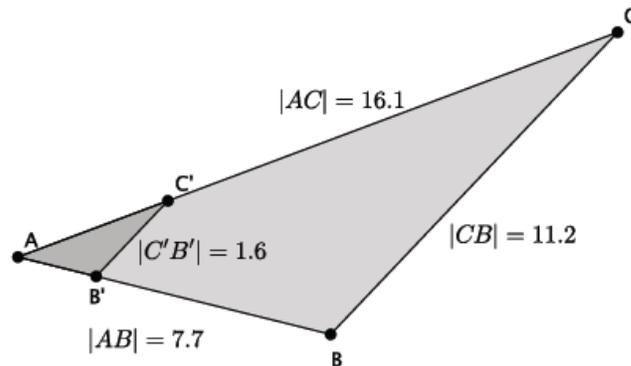

- Based on the information given, is $\triangle ABC \sim \triangle AB'C'$? Explain.
 - Assume line BC is parallel to line $B'C'$. With this information, can you say that $\triangle ABC \sim \triangle AB'C'$? Explain.
 - Given that $\triangle ABC \sim \triangle AB'C'$, determine the length of side AC' .
 - Given that $\triangle ABC \sim \triangle AB'C'$, determine the length of side AB' .
3. In the diagram below, you have $\triangle ABC$ and $\triangle A'B'C'$. Use this information to answer parts (a)–(c).

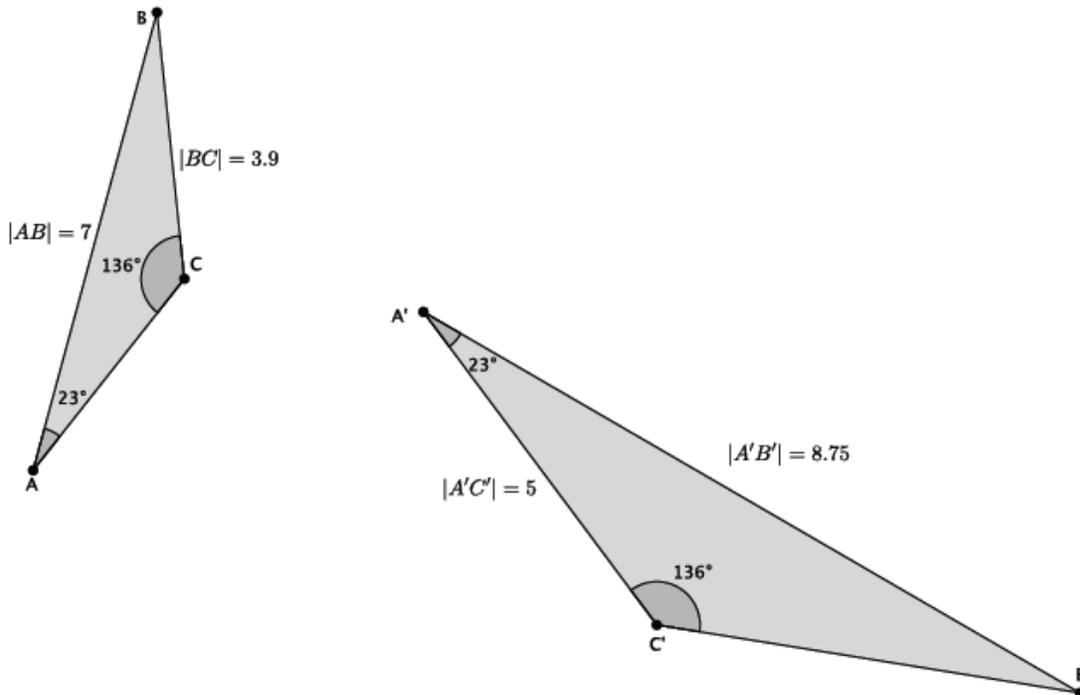

- Based on the information given, is $\triangle ABC \sim \triangle A'B'C'$? Explain.
- Given that $\triangle ABC \sim \triangle A'B'C'$, determine the length of side $B'C'$.
- Given that $\triangle ABC \sim \triangle A'B'C'$, determine the length of side AC .

4. In the diagram below, you have $\triangle ABC$ and $\triangle AB'C'$. Use this information to answer the question below.

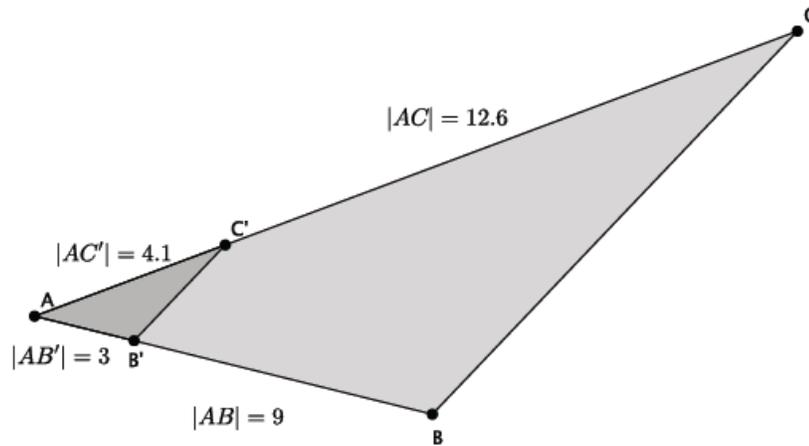

Based on the information given, is $\triangle ABC \sim \triangle AB'C'$? Explain.

5. In the diagram below, you have $\triangle ABC$ and $\triangle A'B'C'$. Use this information to answer parts (a)–(b).

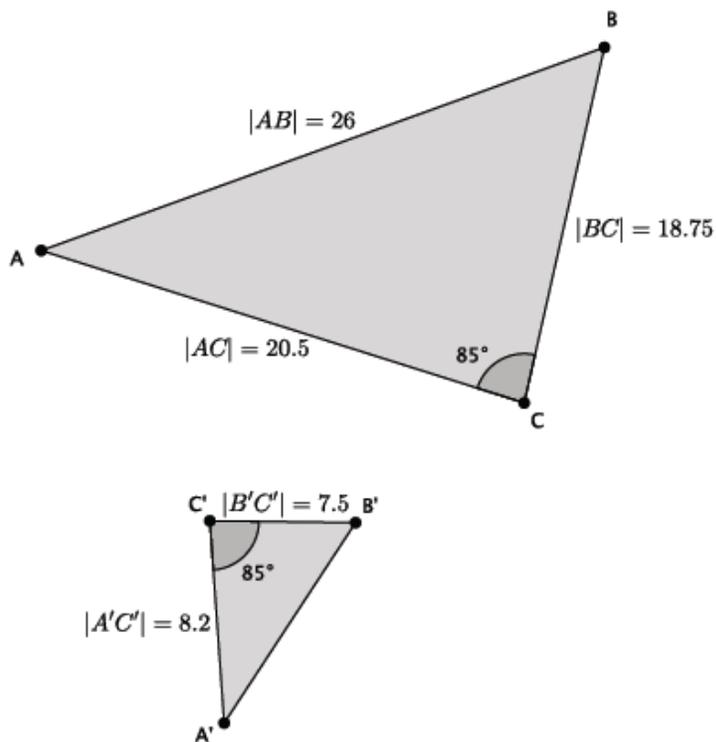

- Based on the information given, is $\triangle ABC \sim \triangle A'B'C'$? Explain.
- Given that $\triangle ABC \sim \triangle A'B'C'$, determine the length of side $A'B'$.

Lesson 12: Modeling Using Similarity

Classwork

Example 1

Not all flagpoles are perfectly *upright* (i.e., perpendicular to the ground). Some are oblique (i.e., neither parallel nor at a right angle, slanted). Imagine an oblique flagpole in front of an abandoned building. The question is, can we use sunlight and shadows to determine the length of the flagpole?

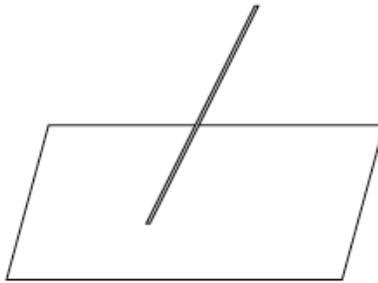

Assume that we know the following information. The length of the shadow of the flagpole is 15 feet. There is a mark on the flagpole 3 feet from its base. The shadow of this three feet portion of the flagpole is 1.7 feet.

Mathematical Modeling Exercises

1. You want to determine the approximate height of one of the tallest buildings in the city. You are told that if you place a mirror some distance from yourself so that you can see the top of the building in the mirror, then you can indirectly measure the height using similar triangles. Let O be the location of the mirror so that the person shown can see the top of the building.

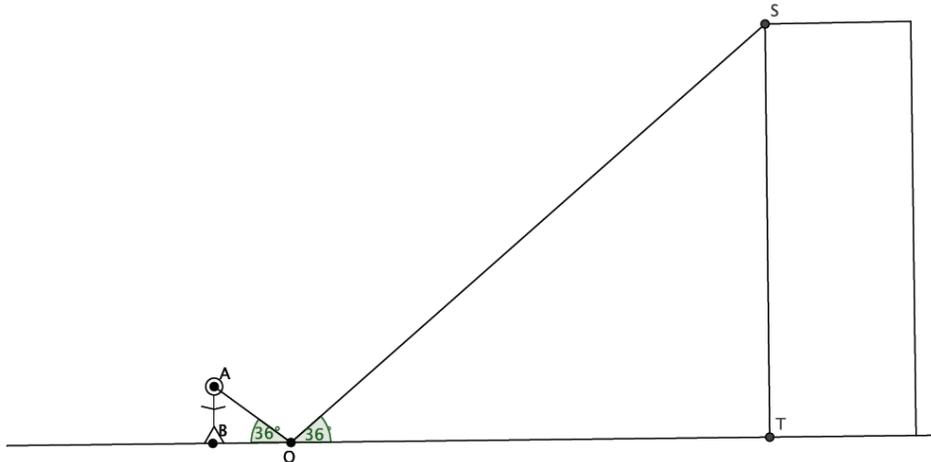

- a. Explain why $\triangle ABO \sim \triangle STO$.
- b. Label the diagram with the following information: The distance from eye-level straight down to the ground is 5.3 feet. The distance from the person to the mirror is 7.2 feet. The distance from the person to the base of the building is 1,750 feet. The height of the building will be represented by x .
- c. What is the distance from the mirror to the building?

- d. Do you have enough information to determine the approximate height of the building? If yes, determine the approximate height of the building. If not, what additional information is needed?

2. A geologist wants to determine the distance across the widest part of a nearby lake. The geologist marked off specific points around the lake so that line DE would be parallel to line BC . The segment BC is selected specifically because it is the widest part of the lake. The segment DE is selected specifically because it was a short enough distance to easily measure. The geologist sketched the situation as shown below.

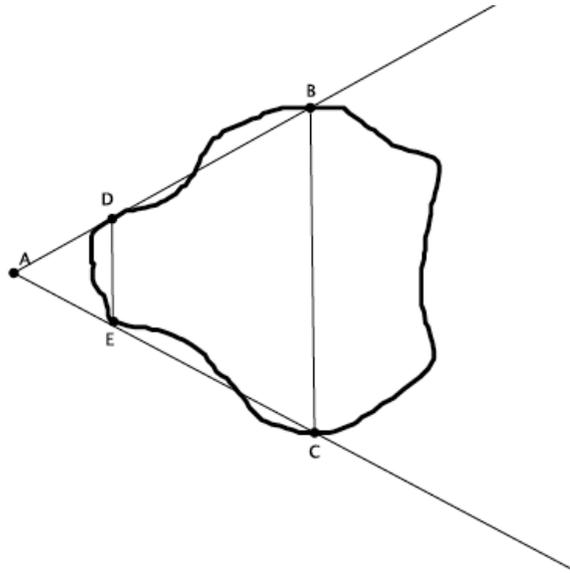

- a. Has the geologist done enough work so far to use similar triangles to help measure the widest part of the lake? Explain.

- b. The geologist has made the following measurements: $|DE| = 5$ feet, $|AE| = 7$ feet, and $|EC| = 15$ feet. Does she have enough information to complete the task? If so, determine the length across the widest part of the lake. If not, state what additional information is needed.
- c. Assume the geologist could only measure a maximum distance of 12 feet. Could she still find the distance across the widest part of the lake? What would need to be done differently?
3. A tree is planted in the backyard of a house with the hope that one day it will be tall enough to provide shade to cool the house. A sketch of the house, tree, and sun is shown below.

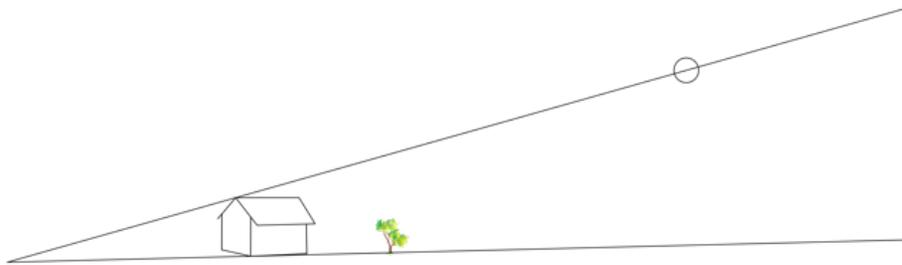

- a. What information is needed to determine how tall the tree must be to provide the desired shade?

- b. Assume that the sun casts a shadow 32 feet long from a point on top of the house to a point in front of the house. The distance from the end of the house's shadow to the base of the tree is 53 feet. If the house is 16 feet tall, how tall must the tree get to provide shade for the house?
- c. Assume that the tree grows at a rate of 2.5 feet per year. If the tree is now 7 feet tall, about how many years will it take for the tree to reach the desired height?

Problem Set

1. The world's tallest living tree is a redwood in California. It's about 370 feet tall. In a local park, there is a very tall tree. You want to find out if the tree in the local park is anywhere near the height of the famous redwood.

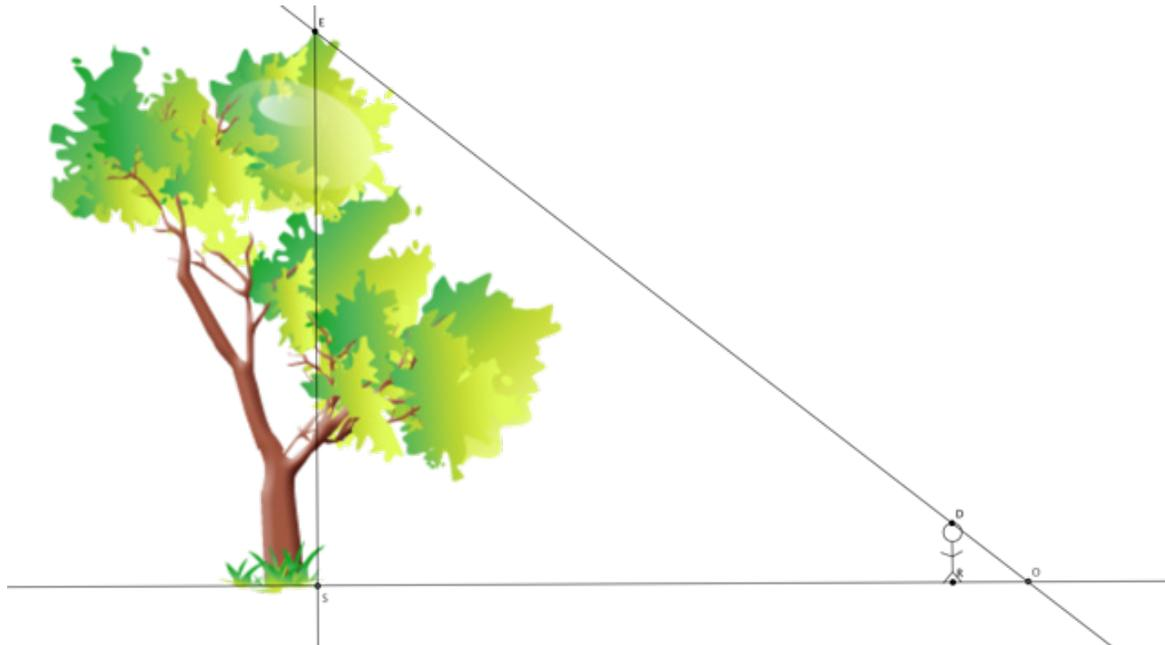

- Describe the triangles in the diagram, and explain how you know they are similar or not.
 - Assume $\triangle ESO \sim \triangle DRO$. A friend stands in the shadow of the tree. He is exactly 5.5 feet tall and casts a shadow of 12 feet. Is there enough information to determine the height of the tree? If so, determine the height. If not, state what additional information is needed.
 - Your friend stands exactly 477 feet from the base of the tree. Given this new information, determine about how many feet taller the world's tallest tree is compared to the one in the local park.
 - Assume that your friend stands in the shadow of the world's tallest redwood and the length of his shadow is just 8 feet long. How long is the shadow cast by the tree?
2. A reasonable skateboard ramp makes a 25° angle with the ground. A two-foot tall ramp requires about 4.3 feet of wood along the base and about 4.7 feet of wood from the ground to the top of the two-foot height to make the ramp.
- Sketch a diagram to represent the situation.
 - Your friend is a daredevil and has decided to build a ramp that is 5 feet tall. What length of wood will be needed to make the base of the ramp? Explain your answer using properties of similar triangles.
 - What length of wood is required to go from the ground to the top of the 5-foot height to make the ramp? Explain your answer using properties of similar triangles.

Lesson 13: Proof of the Pythagorean Theorem

Classwork

Exercises 1–3

Use the Pythagorean Theorem to determine the unknown length of the right triangle.

1. Determine the length of side c in each of the triangles below.

a.

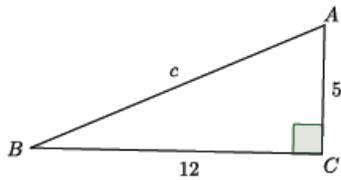

b.

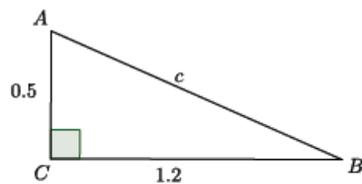

2. Determine the length of side b in each of the triangles below.

a.

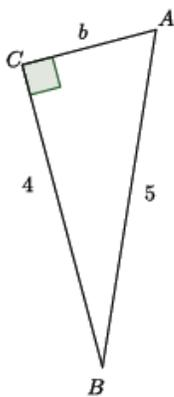

b.

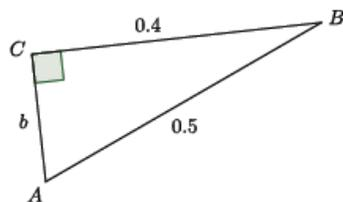

3. Determine the length of QS . (Hint: Use the Pythagorean Theorem twice.)

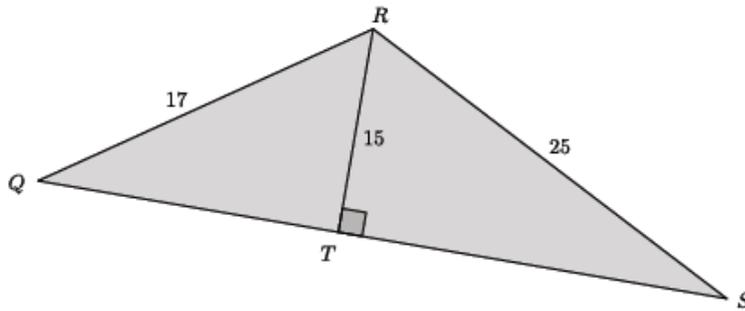

Problem Set

Use the Pythagorean Theorem to determine the unknown length of the right triangle.

1. Determine the length of side c in each of the triangles below.

a.

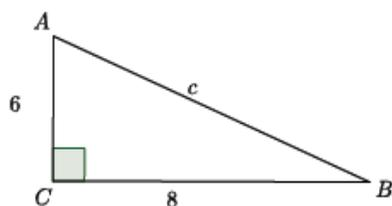

b.

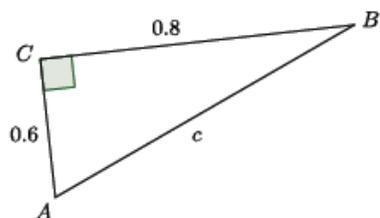

2. Determine the length of side a in each of the triangles below.

a.

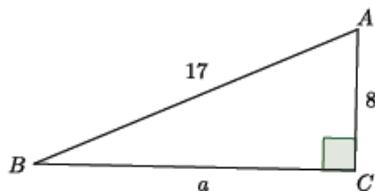

b.

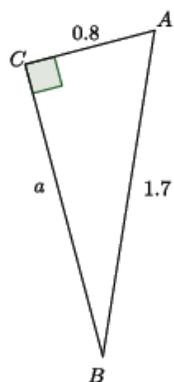

3. Determine the length of side b in each of the triangles below.

a.

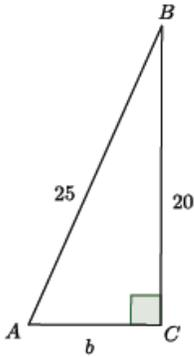

b.

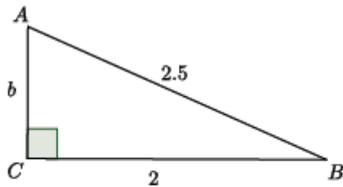

4. Determine the length of side a in each of the triangles below.

a.

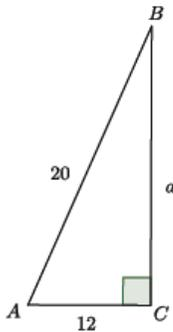

b.

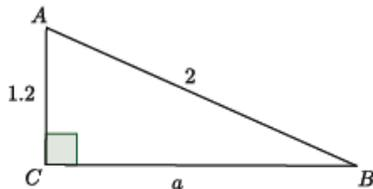

5. What did you notice in each of the pairs of Problems 1–4? How might what you noticed be helpful in solving problems like these?

Lesson 14: The Converse of the Pythagorean Theorem

Classwork

Exercises 1–7

1. The numbers in the diagram below indicate the units of length of each side of the triangle. Is the triangle shown below a right triangle? Show your work, and answer in a complete sentence.

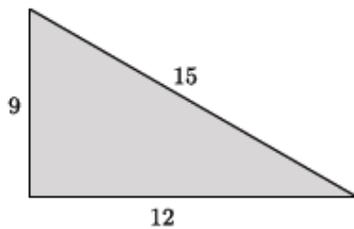

2. The numbers in the diagram below indicate the units of length of each side of the triangle. Is the triangle shown below a right triangle? Show your work, and answer in a complete sentence.

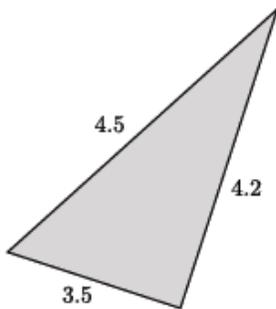

3. The numbers in the diagram below indicate the units of length of each side of the triangle. Is the triangle shown below a right triangle? Show your work, and answer in a complete sentence.

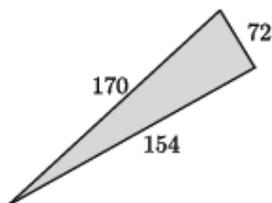

4. The numbers in the diagram below indicate the units of length of each side of the triangle. Is the triangle shown below a right triangle? Show your work, and answer in a complete sentence.

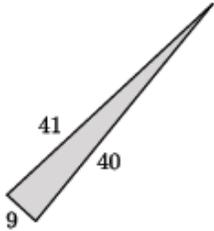

5. The numbers in the diagram below indicate the units of length of each side of the triangle. Is the triangle shown below a right triangle? Show your work, and answer in a complete sentence.

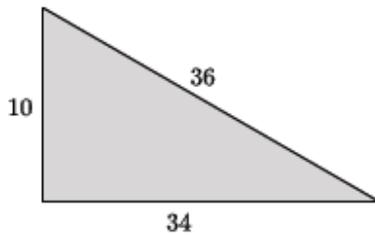

6. The numbers in the diagram below indicate the units of length of each side of the triangle. Is the triangle shown below a right triangle? Show your work, and answer in a complete sentence.

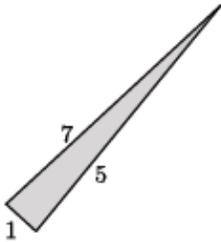

7. The numbers in the diagram below indicate the units of length of each side of the triangle. Is the triangle shown below a right triangle? Show your work, and answer in a complete sentence.

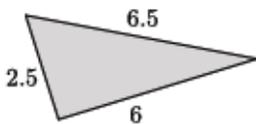

Lesson Summary

The converse of the Pythagorean Theorem states that if side lengths of a triangle a, b, c , satisfy $a^2 + b^2 = c^2$, then the triangle is a right triangle.

If the side lengths of a triangle a, b, c , do not satisfy $a^2 + b^2 = c^2$, then the triangle is not a right triangle.

Problem Set

1. The numbers in the diagram below indicate the units of length of each side of the triangle. Is the triangle shown below a right triangle? Show your work, and answer in a complete sentence.

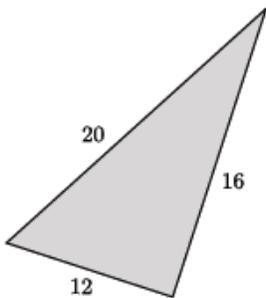

2. The numbers in the diagram below indicate the units of length of each side of the triangle. Is the triangle shown below a right triangle? Show your work, and answer in a complete sentence.

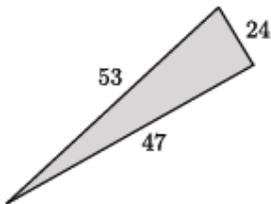

3. The numbers in the diagram below indicate the units of length of each side of the triangle. Is the triangle shown below a right triangle? Show your work, and answer in a complete sentence.

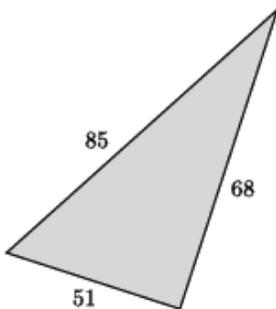

4. The numbers in the diagram below indicate the units of length of each side of the triangle. Sam said that the following triangle is a right triangle. Explain to Sam what he did wrong to reach this conclusion and what the correct solution is.

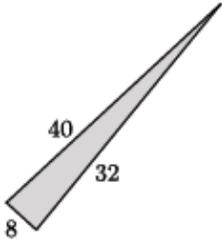

5. The numbers in the diagram below indicate the units of length of each side of the triangle. Is the triangle shown below a right triangle? Show your work, and answer in a complete sentence.

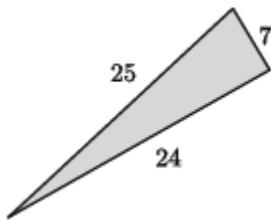

6. Jocelyn said that the triangle below is not a right triangle. Her work is shown below. Explain what she did wrong, and show Jocelyn the correct solution.

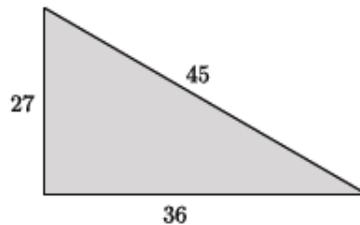

We need to check if $27^2 + 45^2 = 36^2$ is a true statement. The left side of the equation is equal to 2,754. The right side of the equation is equal to 1,296. That means $27^2 + 45^2 = 36^2$ is not true, and the triangle shown is not a right triangle.